



Baudot – Strings

Design by Allermuir

Baudot Strings provide an attractive alternative solution to screening whilst noticeably improving the acoustics within a space. Constructed from extruded Aluminum poles surrounded by foam and fabric, Strings provide an excellent surface

to absorb and diffuse sound waves. With 24 fabric colors and various heights available, interior designers can create an arrangement to fit in any environment.

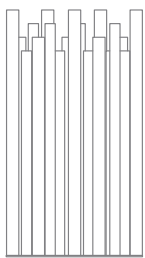

BDSR20

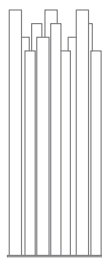

BDSR12

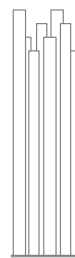
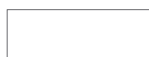

BDSR8



BDSC12

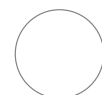

Design Allermuir

Our team of talented in house designers is responsible for creating elegant, innovative furniture designs that not only look beautiful, but minimise the impact on the world around us.

Constantly exploring new product trends and keeping up to date with the latest innovations in technology and materials, our design team creates world class designs of the highest quality.

Standard Features

Upholstered uprights finished in acoustically tested fabrics
 Steel base plate finished in Black powder coat

Optional Features

Two-tone Upholstery

Dimensions

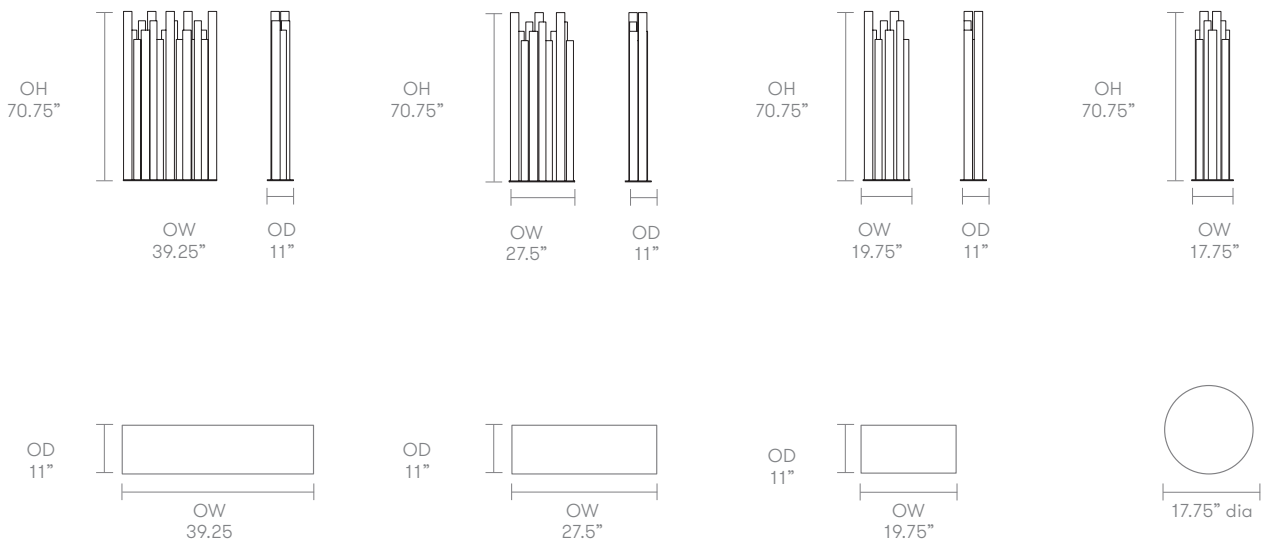

Environmental Performance

Material Content

Components are constructed of the following

Recycled Content

Contains up to 61.50% of Recycled Material

Recyclability

The range is 100% recyclable

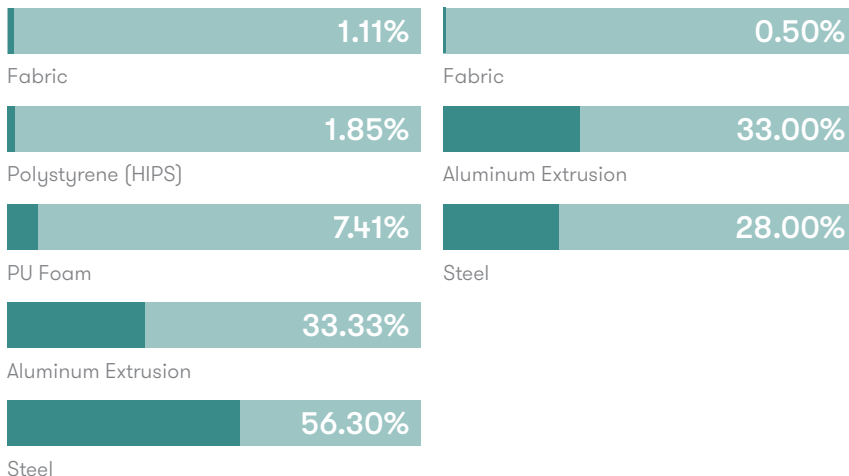

100%

Finish Options

Available in Baudot Synergy fabrics only
Steel base plate finished in Black powder coat

Fabrics

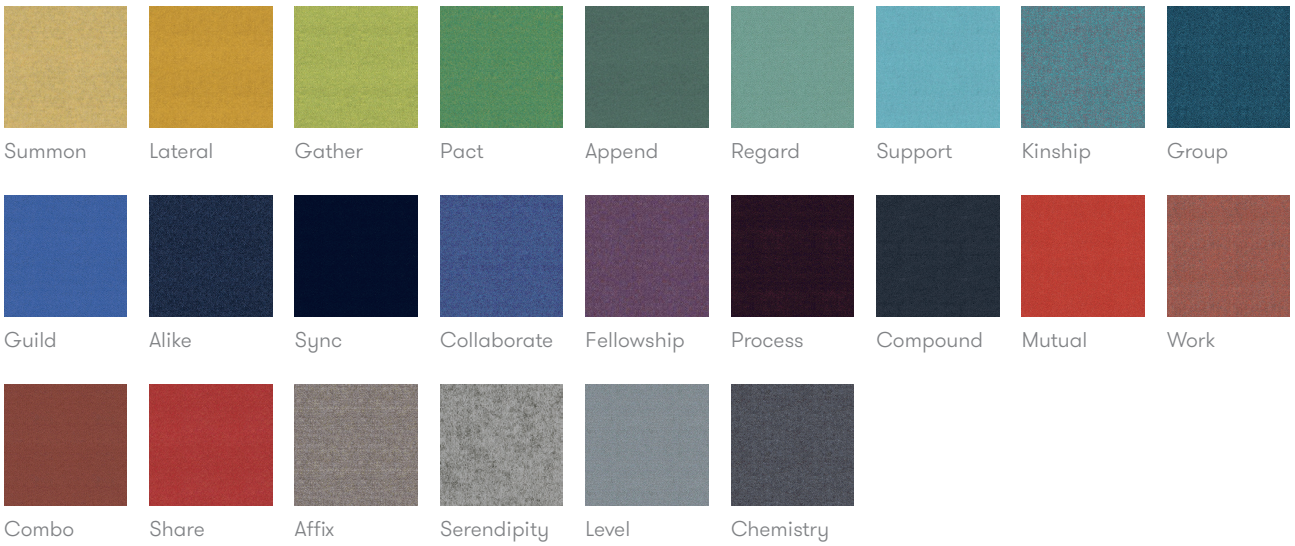

Note: Color images are for reference only. Please verify with actual color sample.

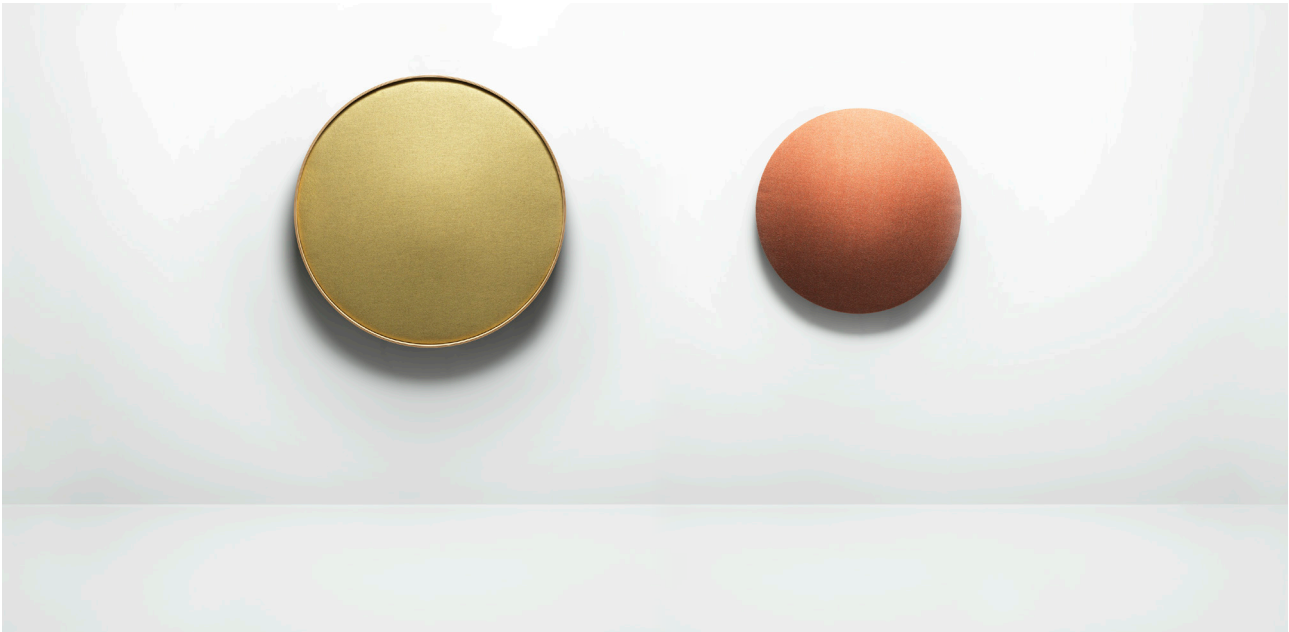

Baudot - Zero Wall

Design by Allermuir

A domed wall mounted shape to improve acoustics without losing floor space. Available in a combination of three sizes and 24 colors, Baudot Zero Wall diffuses

noise by both absorbing and deflecting sound, while adding visual interest to walls.



BDZ2
BDZ3 (Wood Frame)



BDZ4
BDZ5 (Wood Frame)

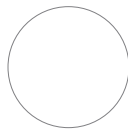

BDZ6
BDZ7 (Wood Frame)



Design Allermuir

Our team of talented in house designers is responsible for creating elegant, innovative furniture designs that not only look beautiful, but minimize the impact on the world around us.

Constantly exploring new product trends and keeping up to date with the latest innovations in technology and materials, our design team creates world class designs of the highest quality.

Standard Features

(* - Selected models only)

Foam construction

Upholstered in acoustically tested fabrics

Solid Ash frame with a clear finish*

Dimensions

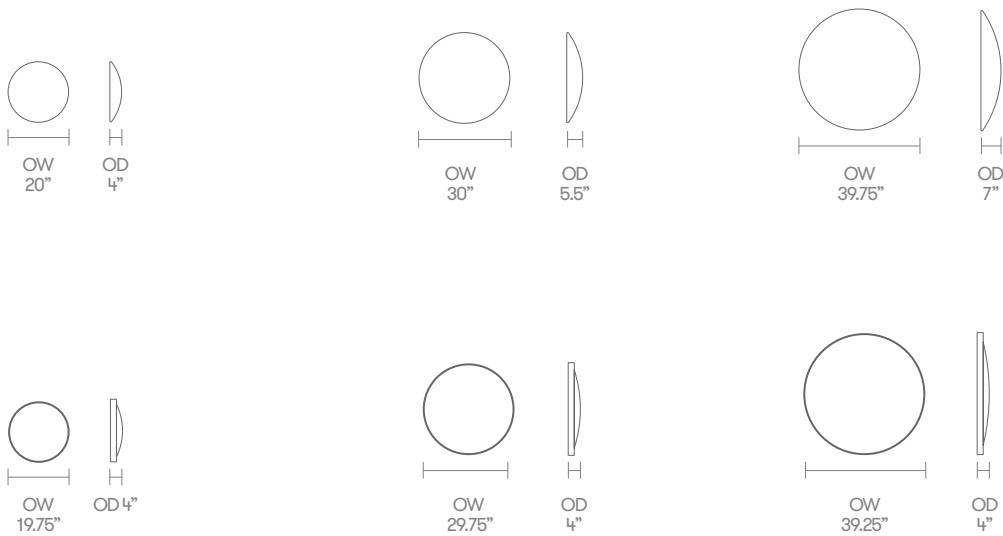

Environmental Performance

Material Content

Components are constructed of the following

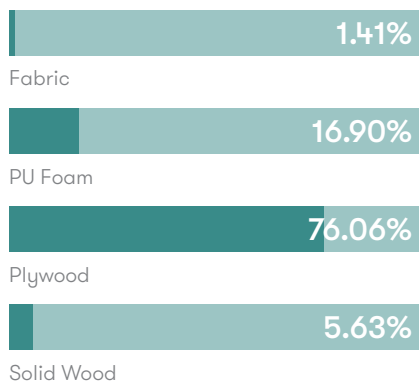

Recycled Content

Contains up to 0.50% of Recycled Material



Recyclability

The range is 100% recyclable

100%

Finish Options

(* - Selected models only)

Solid Ash frame can be stained or color washed*

Available in Baudot Synergy fabrics only

Frame Finish



Solid Ash (standard)

Wood Stains based on Ash



White Oak wood stain



Wenge wood stain



Dark Walnut wood stain



American Walnut wood stain

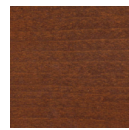

American Cherry wood stain

Fabrics



Summon



Lateral



Gather



Pact



Append



Regard



Support

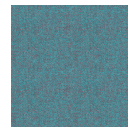

Kinship

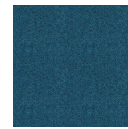

Group



Guild



Alike



Sync



Collaborate



Fellowship



Process



Compound



Mutual

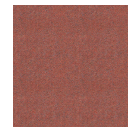

Work



Combo



Share



Affix

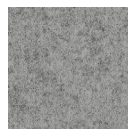

Serendipity



Level

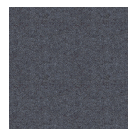

Chemistry