

Offline Directory

Everything you need in one place.

This Directory contains every piece of Allermuir product information you need to help you specify and order your desired product.

Should you want to know more simply scan the QR code to be taken to the product page on the Allermuir website where you can download, CAD, imagery and fabric approval sheet and price list.

Chairs and Stools

06 – 57

Axyl ⁰⁸ / Bastille ¹⁴ / Cardita ¹⁵
 Casper ¹⁶ / Crop ⁰⁰ / Famiglia ²¹ / Folk ²⁶
 Jojo ³⁰ / Kin ³¹ / Mollie ⁰⁴⁵ / Ooty ⁴⁷
 Phoulds ⁴⁸ / Scoop ⁵⁴ / Tommo ⁵⁵

Soft Seating

58 – 97

Conic ⁶⁰ / Famiglia ⁶² / Fifty Series ⁶⁷
 Grainger ⁷⁰ / Haven ⁷² / Haven Bench ⁷⁴
 Jinx ⁷⁶ / Lola ⁷⁷ / Mayze Mobile ⁷⁹ / Mozaik ⁸⁰
 Open ⁸² / Pause ⁸⁴ / Pebble ⁸⁷ / Plum ⁸⁸
 Qu ⁰⁹² / Tarry ⁹³ / Tylus & Cushions ⁹⁴ / Venus ⁹⁶

Ottomans & Benches

98 – 113

Grainger ¹⁰⁰ / Haven Bench ¹⁰¹ / Mayze ¹⁰³
 Mozaik ¹⁰⁴ / Pause ¹⁰⁶ / Paver ¹⁰⁸ / Pebble ¹¹⁰
 Plum ¹¹¹ / Qu ¹¹² / Stirling ¹¹³

Sofas

114 – 129

Mayze ¹¹⁶ / Obris ¹¹⁸ / Orai ¹¹⁹
 Oran ¹²⁰ / Paver ¹²² / Plum ¹²⁴ / Stirling ¹²⁸

Tables

130 – 163

Axyl ¹³² / Batan ¹³⁴ / Cirque ¹³⁷
 Conic ¹³⁹ / Folk ¹⁴⁰ / Folk Environmental ¹⁴¹
 FortySeven ¹⁴² / FortySeven XL ¹⁴⁸ / Host ¹⁵¹
 Oran ¹⁵² / Pache ¹⁵³ / Silta ¹⁵⁶ / Sunda 1 ¹⁵⁸
 Sunda 2 ¹⁵⁹ / Tibo ¹⁶⁰ / Turo ¹⁶¹
 Turo Environmental ¹⁶²

Outdoor

164 – 171

Axyl Outdoor ¹⁶⁶ / Crop Outdoor ¹⁷⁰
 Tibo Outdoor ¹⁷¹

Storage

172 – 185

Crate Divide ¹⁷⁴ / Crate ¹⁸² / Crate Caddy ¹⁸³
 Furow ¹⁸⁴ / Mozaik Storage ¹⁸⁵

Finishes

186 – 205

Resources

206 – 211

Contents

008	Axyl
014	Bastille
015	Cardita
016	Casper
020	Crop
021	Famiglia
026	Folk
030	Jojo
031	Kin
045	Mollie
047	Ooty
048	Phoulds
054	Scoop
055	Tommo

6

7

Chairs and Stools

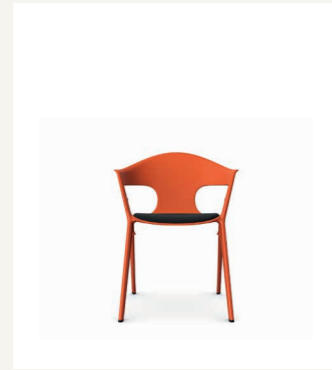
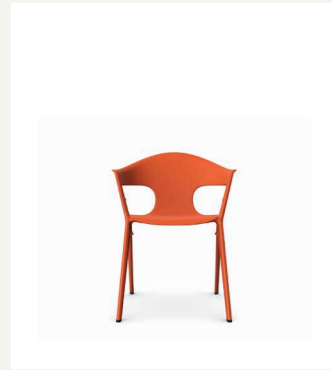

AXYL - AXL02 Arm chair

Dimensions:

Seat Height	17.75"
Seat Width	16.25"
Seat Depth	17.25"
Overall Height	30.75"
Overall Width	23.75"
Overall Depth	22.25"

Standard Features:

- Plastic shell finished in Black
- Cast Aluminum frame finished in Matte Black powder coat
- Stacking buffers
- Plastic glides
- Stacks up to 4 high

Optional Features:

- Plastic shell with complementary Aluminum powder coat frame available in a selection of colors
- Wood fiber injected plastic shell with complementary Aluminum frame
- Polished Aluminum frame
- Plastic glides with felt

Frame Finishes:

Matte Black	
Basalt	
Peacock Blue	
Sage	
Coral	
Matte White	
Stone	
Pebble	
Polished Aluminum	

Shell Finishes:

Black	
Basalt	
Peacock Blue	
Sage	
Coral	
White	
Pebble (Wood Fiber)	
Stone (Wood Fiber)	

For larger swatches go to pg.188-205



AXYL - AXL02U Arm chair with upholstered seat pad

Dimensions:

Seat Height	17.75"
Seat Width	16.25"
Seat Depth	17.25"
Overall Height	30.75"
Overall Width	23.75"
Overall Depth	22.25"

Standard Features:

- Plastic shell finished in Black
- Upholstered seat pad
- Cast Aluminum frame finished in Matte Black powder coat
- Stacking buffers
- Plastic glides
- Stacks up to 4 high

Optional Features:

- Plastic shell with complementary Aluminum powder coat frame available in a selection of colors
- Wood fiber injected plastic shell with complementary Aluminum frame
- Polished Aluminum frame
- Plastic glides with felt

Frame Finishes:

Matte Black	
Basalt	
Peacock Blue	
Sage	
Coral	
Matte White	
Stone	
Pebble	
Polished Aluminum	

Shell Finishes:

Black	
Basalt	
Peacock Blue	
Sage	
Coral	
White	
Pebble (Wood Fiber)	
Stone (Wood Fiber)	

For larger swatches go to pg.188-205

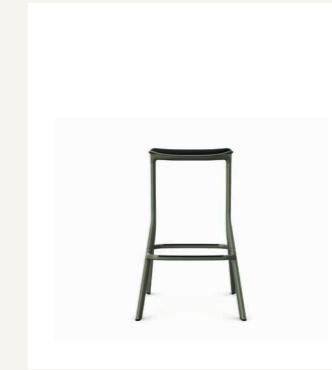

Axyl - AXL04 High stool

Dimensions:

Seat Height	30"
Seat Width	15.75"
Seat Depth	15.25"
Overall Height	29.5"
Overall Width	19.5"
Overall Depth	18.5"

Standard Features:

- Plastic seat finished in Black
- Cast Aluminum frame finished in Matte Black powder coat
- Integral Plastic footrest protectors
- Plastic glides

Optional Features:

- Plastic seat with complementary Aluminum powder coat frame available in a selection of colors
- Wood fiber injected plastic seat with complementary Aluminum frame
- Polished Aluminum frame
- Plastic glides with felt

Frame Finishes:

Matte Black	
Basalt	
Peacock Blue	
Sage	
Coral	
Matte White	
Stone	
Pebble	
Polished Aluminum	

Shell Finishes:

Black	
Basalt	
Peacock Blue	
Sage	
Coral	
White	
Pebble (Wood Fiber)	
Stone (Wood Fiber)	

For larger swatches go to pg.188-205



Axyl - AXL04U High stool with upholstered seat pad

Dimensions:

Seat Height	30"
Seat Width	15.75"
Seat Depth	15.25"
Overall Height	29.5"
Overall Width	19.5"
Overall Depth	18.5"

Standard Features:

- Plastic seat finished in Black
- Upholstered seat pad
- Cast Aluminum frame finished in Matte Black powder coat
- Integral Plastic footrest protectors
- Plastic glides

Optional Features:

- Plastic seat with complementary Aluminum powder coat frame available in a selection of colors
- Wood fiber injected plastic seat with complementary Aluminum frame
- Polished Aluminum frame
- Plastic glides with felt

Frame Finishes:

Matte Black	
Basalt	
Peacock Blue	
Sage	
Coral	
Matte White	
Stone	
Pebble	
Polished Aluminum	

Shell Finishes:

Black	
Basalt	
Peacock Blue	
Sage	
Coral	
White	
Pebble (Wood Fiber)	
Stone (Wood Fiber)	

For larger swatches go to pg.188-205



↓ Scan here to discover more



↓ Scan here to discover more



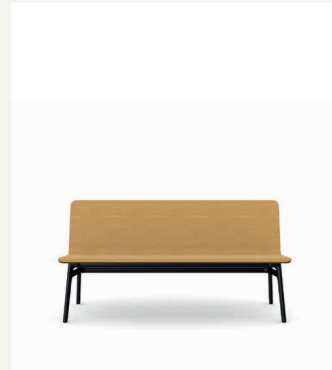

Axyl Bench - AXLB16
Bench wood shell

Dimensions:
 Seat Height 17.25"
 Seat Width 63"
 Seat Depth 17.25"
 Overall Height 32"
 Overall Width 63"
 Overall Depth 25.75"

- Standard Features:
- Oak veneer ply shell with a clear finish
 - Cast Aluminum frame and extrusions finished in Matte Black powder coat
 - Plastic glides with leveling adjustment

- Optional Features:
- Cast Aluminum frame available in a selection of powder coat finishes
 - Oak veneer ply shell can be stained or color washed to complement frame finish
 - Plastic glides with felt and leveling adjustment

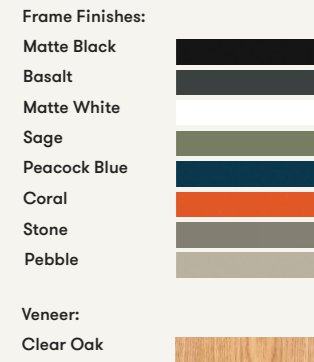

For larger swatches go to pg.188-205

6 optional Wood Stains and 8 color washes based on Oak are also available please go to pg. 193 and 195 to see more.

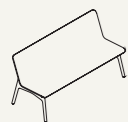

Axyl Bench - AXLB16U2
Bench with arms and wood shell

Dimensions:
 Seat Height 17.25"
 Seat Width 55.5"
 Seat Depth 17.25"
 Arm Height 25.25"
 Overall Height 32"
 Overall Width 63"
 Overall Depth 25.75"

- Standard Features:
- Oak veneer ply shell with a clear finish
 - Cast Aluminum frame and extrusions finished in Matte Black powder coat
 - Cast Aluminum arms finished in Black powder coat
 - Plastic glides with leveling adjustment

- Optional Features:
- Cast Aluminum frame and arms available in a selection of powder coat finishes
 - Oak veneer ply shell can be stained or color washed to complement frame finish
 - Plastic glides with felt and leveling adjustment

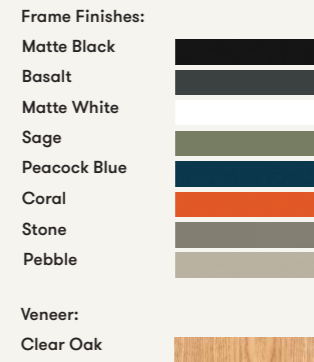

For larger swatches go to pg.188-205

6 optional Wood Stains and 8 color washes based on Oak are also available please go to pg. 193 and 195 to see more.

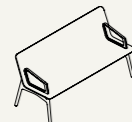

Axyl Bench - AXLB16U2
Bench with upholstered inner shell

Dimensions:
 Seat Height 17.25"
 Seat Width 63"
 Seat Depth 17.25"
 Overall Height 32"
 Overall Width 63"
 Overall Depth 25.75"

- Standard Features:
- Upholstered inner shell and Oak veneer ply outer with a clear finish
 - Cast Aluminum frame and extrusions finished in Matte Black powder coat
 - Plastic glides with leveling adjustment

- Optional Features:
- Cast Aluminum frame available in a selection of powder coat finishes
 - Oak veneer ply shell can be stained or color washed to complement frame finish
 - Plastic glides with felt and leveling adjustment

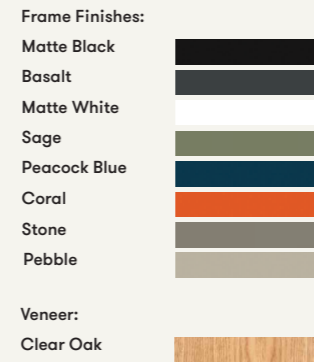

For larger swatches go to pg.188-205

6 optional Wood Stains and 8 color washes based on Oak are also available please go to pg. 193 and 195 to see more.

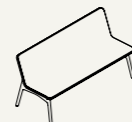

↓ Scan here to discover more

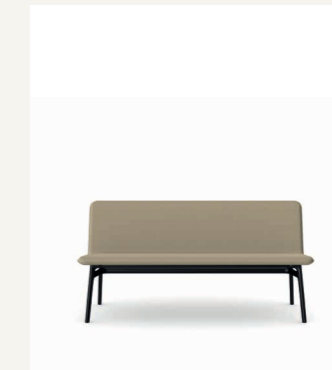

Axyl Bench - AXLB16U2
Bench with arms, upholstered inner shell

Dimensions:
 Seat Height 17.25"
 Seat Width 55.5"
 Seat Depth 17.25"
 Arm Height 25.25"
 Overall Height 32"
 Overall Width 63"
 Overall Depth 25.75"

- Standard Features:
- Upholstered inner shell and Oak veneer ply outer with a clear finish
 - Cast Aluminum frame and extrusions finished in Matte Black powder coat
 - Cast Aluminum arms finished in Black powder coat
 - Plastic glides with leveling adjustment

- Optional Features:
- Cast Aluminum frame and arms available in a selection of powder coat finishes
 - Oak veneer ply shell can be stained or color washed to complement frame finish
 - Plastic glides with felt and leveling adjustment

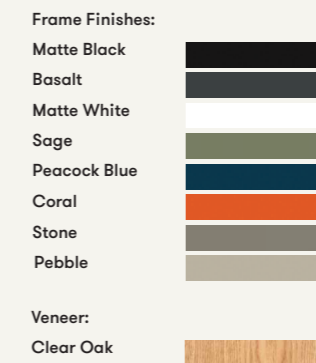

For larger swatches go to pg.188-205

6 optional Wood Stains and 8 color washes based on Oak are also available please go to pg. 193 and 195 to see more.

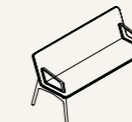

Axyl Bench - AXLB16U3
Bench fully upholstered

Dimensions:
 Seat Height 18"
 Seat Width 54.25"
 Seat Depth 17.25"
 Overall Height 32"
 Overall Width 64.5"
 Overall Depth 25.75"

- Standard Features:
- Fully Upholstered shell
 - Cast Aluminum frame and extrusions finished in Matte Black powder coat
 - Plastic glides with leveling adjustment

- Optional Features:
- Cast Aluminum frame available in a selection of powder coat finishes
 - Plastic glides with felt and leveling adjustment

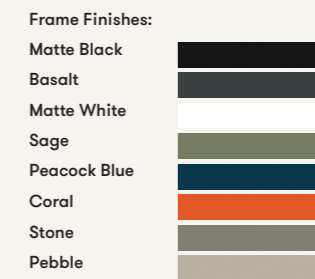

For larger swatches go to pg.188-205

Axyl Bench - AXLB16U3
Bench with arms, fully upholstered

Dimensions:
 Seat Height 18"
 Seat Width 54.25"
 Seat Depth 17.25"
 Arm Height 27.25"
 Overall Height 32"
 Overall Width 64.5"
 Overall Depth 25.75"

- Standard Features:
- Fully Upholstered shell
 - Cast Aluminum frame and extrusions finished in Matte Black powder coat
 - Fully Upholstered arms
 - Plastic glides with leveling adjustment

- Optional Features:
- Cast Aluminum frame available in a selection of powder coat finishes
 - Plastic glides with felt and leveling adjustment

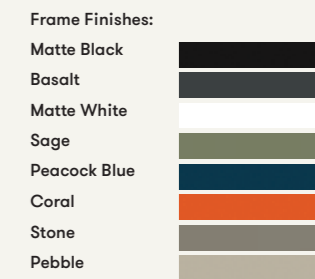

For larger swatches go to pg.188-205

↓ Scan here to discover more

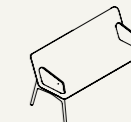
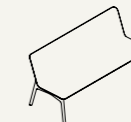

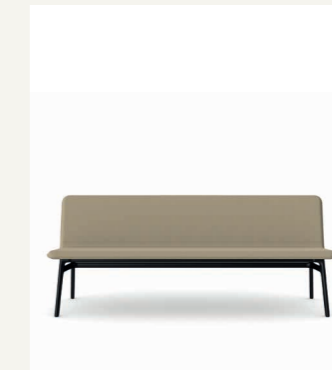

Axyl Bench - AXLB20
Bench wood shell

Dimensions:
 Seat Height 17.25"
 Seat Width 78.75"
 Seat Depth 17.25"
 Overall Height 32"
 Overall Width 78.75"
 Overall Depth 25.75"

- Standard Features:
- Oak veneer ply shell with a clear finish
 - Cast Aluminum frame and extrusions finished in Matte Black powder coat
 - Plastic glides with leveling adjustment

- Optional Features:
- Cast Aluminum frame available in a selection of powder coat finishes
 - Oak veneer ply shell can be stained or color washed to complement frame finish
 - Plastic glides with felt and leveling adjustment

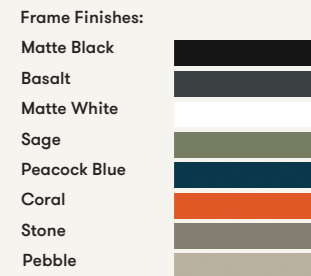

For larger swatches go to pg.188-205

6 optional Wood Stains and 8 color washes based on Oak are also available please go to pg. 193 and 195 to see more.

Axyl Bench - AXLBA20
Bench with arms and wood shell

Dimensions:
 Seat Height 17.25"
 Seat Width 71.25"
 Seat Depth 17.25"
 Arm Height 25.25"
 Overall Height 32"
 Overall Width 78.75"
 Overall Depth 25.75"

- Standard Features:
- Oak veneer ply shell with a clear finish
 - Cast Aluminum frame and extrusions finished in Matte Black powder coat
 - Cast Aluminum arms finished in Black powder coat
 - Plastic glides with leveling adjustment

- Optional Features:
- Cast Aluminum frame and arms available in a selection of powder coat finishes
 - Oak veneer ply shell can be stained or color washed to complement frame finish
 - Plastic glides with felt and leveling adjustment

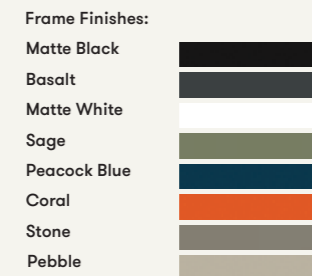

For larger swatches go to pg.188-205

6 optional Wood Stains and 8 color washes based on Oak are also available please go to pg. 193 and 195 to see more.

Axyl Bench - AXLB20U2
Bench with upholstered inner shell

Dimensions:
 Seat Height 17.25"
 Seat Width 78.75"
 Seat Depth 17.25"
 Overall Height 32"
 Overall Width 78.75"
 Overall Depth 25.75"

- Standard Features:
- Upholstered inner shell and Oak veneer ply outer with a clear finish
 - Cast Aluminum frame and extrusions finished in Matte Black powder coat
 - Plastic glides with leveling adjustment

- Optional Features:
- Cast Aluminum frame available in a selection of powder coat finishes
 - Oak veneer ply shell can be stained or color washed to complement frame finish
 - Plastic glides with felt and leveling adjustment

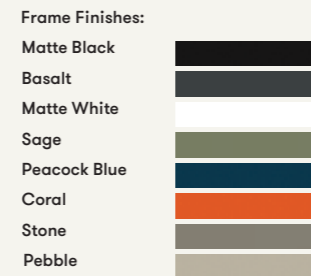

For larger swatches go to pg.188-205

6 optional Wood Stains and 8 color washes based on Oak are also available please go to pg. 193 and 195 to see more.

↓ Scan here to discover more



↓ Scan here to discover more



Axyl Bench - AXLBA20U2
Bench with arms, upholstered inner shell

Dimensions:
 Seat Height 17.25"
 Seat Width 71.25"
 Seat Depth 17.25"
 Arm Height 25.25"
 Overall Height 32"
 Overall Width 78.75"
 Overall Depth 25.75"

- Standard Features:
- Upholstered inner shell and Oak veneer ply outer with a clear finish
 - Cast Aluminum frame and extrusions finished in Matte Black powder coat
 - Cast Aluminum arms finished in Black powder coat
 - Plastic glides with leveling adjustment

- Optional Features:
- Cast Aluminum frame and arms available in a selection of powder coat finishes
 - Oak veneer ply shell can be stained or color washed to complement frame finish
 - Plastic glides with felt and leveling adjustment

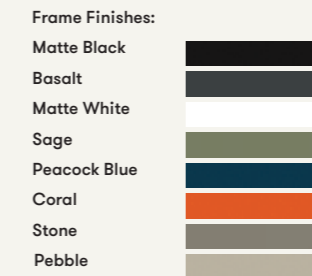

For larger swatches go to pg.188-205

6 optional Wood Stains and 8 color washes based on Oak are also available please go to pg. 193 and 195 to see more.

Axyl Bench - AXLB20U3
Bench fully upholstered

Dimensions:
 Seat Height 18"
 Seat Width 70"
 Seat Depth 17.25"
 Overall Height 32"
 Overall Width 80.25"
 Overall Depth 25.75"

- Standard Features:
- Fully Upholstered shell
 - Cast Aluminum frame and extrusions finished in Matte Black powder coat
 - Plastic glides with leveling adjustment

- Optional Features:
- Cast Aluminum frame available in a selection of powder coat finishes
 - Plastic glides with felt and leveling adjustment

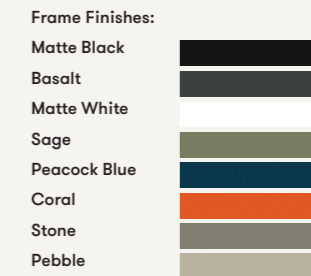

For larger swatches go to pg.188-205

Axyl Bench - AXLBA20U3
Bench with arms, fully upholstered

Dimensions:
 Seat Height 18"
 Seat Width 70"
 Seat Depth 17.25"
 Arm Height 27.25"
 Overall Height 32"
 Overall Width 80.25"
 Overall Depth 25.75"

- Standard Features:
- Fully Upholstered shell
 - Cast Aluminum frame and extrusions finished in Matte Black powder coat
 - Fully Upholstered arms
 - Plastic glides with leveling adjustment

- Optional Features:
- Cast Aluminum frame available in a selection of powder coat finishes
 - Plastic glides with felt and leveling adjustment

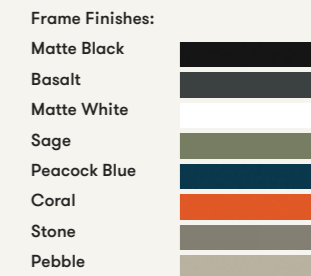

For larger swatches go to pg.188-205

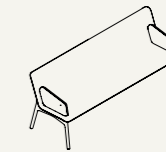
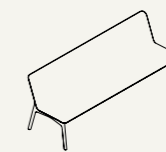
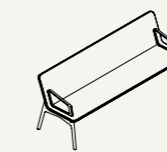
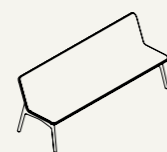
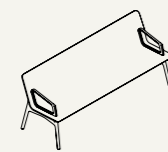
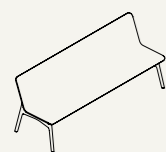

Bastille

Design by Patrick Norguet

14

15

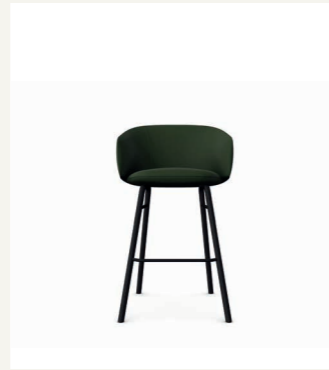
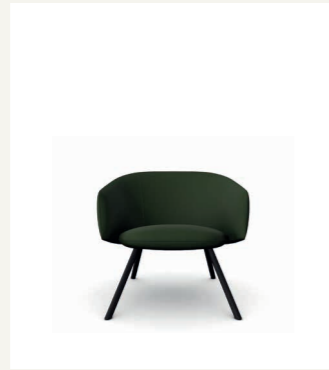
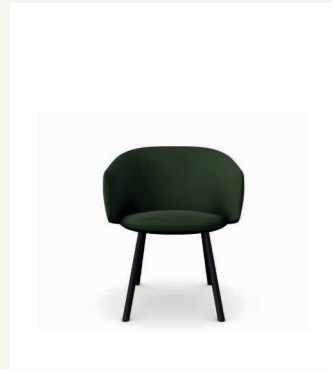

Bastille - BST01 Dining Chair

Dimensions:

Seat Height	18.5"
Seat Width	18"
Seat Depth	18"
Overall Height	30.75"
Overall Width	24.75"
Overall Depth	23.25"

Standard Features:

- Molded foam construction
- Fully upholstered with perimeter piping
- Tubular Steel frame finished in New Black powder coat
- Plastic glides

Optional Features:

- Tubular Steel frame available in a selection of powder coat finishes
- Plastic glides with felt

Frame Finishes:

New Black	
Soft Silver	
Soft Gold	
Deep Mulberry	
Dark Bronze	

For larger swatches go to pg.188-205

Bastille - BST03 Lounge Chair

Dimensions:

Seat Height	16"
Seat Width	21.75"
Seat Depth	20"
Overall Height	26.5"
Overall Width	29.25"
Overall Depth	27.75"

Standard Features:

- Molded foam construction
- Fully upholstered with perimeter piping
- Tubular Steel frame finished in New Black powder coat
- Plastic glides

Optional Features:

- Tubular Steel frame available in a selection of powder coat finishes
- Plastic glides with felt

Frame Finishes:

New Black	
Soft Silver	
Soft Gold	
Deep Mulberry	
Dark Bronze	

For larger swatches go to pg.188-205

Bastille - BST05 Bar Stool

Dimensions:

Seat Height	29.5"
Seat Width	17.75"
Seat Depth	17"
Overall Height	39.5"
Overall Width	24"
Overall Depth	24"

Standard Features:

- Molded foam construction
- Fully upholstered with perimeter piping
- Tubular Steel frame finished in New Black powder coat
- Footrest protector
- Plastic glides

Optional Features:

- Tubular Steel frame available in a selection of powder coat finishes
- Plastic glides with felt
- Counter height stool option, seat height 24.5" (add CH to product code)

Frame Finishes:

New Black	
Soft Silver	
Soft Gold	
Deep Mulberry	
Dark Bronze	

For larger swatches go to pg.188-205



↓ Scan here to discover more



↓ Scan here to discover more



Cardita

Design by Martin Ballendat



Cardita - CRD01 Side chair

Dimensions:

Seat Height	17.25"
Seat Width	19"
Seat Depth	17.25"
Overall Height	32.75"
Overall Width	21.75"
Overall Depth	24.5"

Standard Features:

- Molded Foam shell
- Fully upholstered with luxury quilt detail
- Solid Ash legs with a clear finish
- Plastic glides

Optional Features:

- Solid Ash legs can be stained or color washed
- Plastic glides with felt
- Two-tone upholstery

Wood Stains based on Ash:

Clear	
White Oak	
American Cherry	
American Walnut	
Dark Walnut	
Wenge	

For larger swatches go to pg.188-205

16 optional standard color washes based on Ash are also available please go to pg.194 to see more.

Cardita - CRD03 Stool

Dimensions:

Seat Height	28.75"
Seat Width	17.25"
Seat Depth	14.5"
Overall Height	39.75"
Overall Width	19.75"
Overall Depth	20.25"

Standard Features:

- Molded Foam shell
- Fully upholstered with luxury quilt detail
- Solid Ash legs with a clear finish
- Tubular Steel footrest finished in Polished Chrome
- Plastic glides

Optional Features:

- Solid Ash legs can be stained or color washed
- Plastic glides with felt
- Two-tone upholstery
- Counter height stool option, seat height 24.5"

Wood Stains based on Ash:

Clear	
White Oak	
American Cherry	
American Walnut	
Dark Walnut	
Wenge	

Footrest Finish:

Polished Chrome	
-----------------	--

For larger swatches go to pg.188-205

16 optional standard color washes based on Ash are also available please go to pg.194 to see more.



Casper

Design by Allermuir Design Studio

16

17

Casper

Design by Allermuir Design Studio

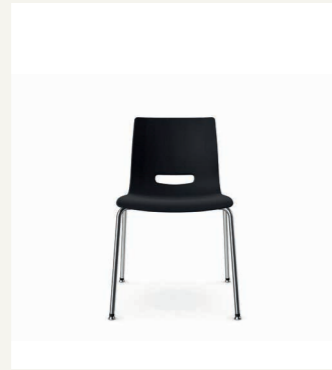
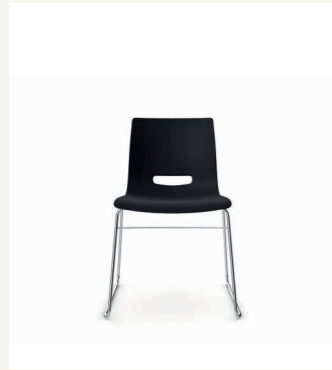

Casper - CS1
Side chair on a skid frame

Dimensions:
 Seat Height 18.5"
 Seat Width 18"
 Seat Depth 17.25"
 Overall Height 32"
 Overall Width 22"
 Overall Depth 21.75"

- Standard Features:
- Plastic shell available in a selection of colors
 - Wire frame finished in Polished Chrome
 - Plastic glides
 - Stacks (on trolley) up to 21 high

- Optional Features:
- Detachable writing tablet
 - Plastic glides with felt
 - Chair trolley(CF Trolley): MX1005BL

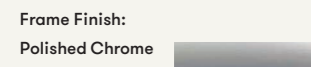
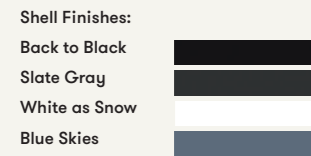

For larger swatches go to pg.188-205

Casper - CS2
Side chair on a 4 leg frame

Dimensions:
 Seat Height 18.5"
 Seat Width 18"
 Seat Depth 17.25"
 Overall Height 32"
 Overall Width 21.75"
 Overall Depth 21.75"

- Standard Features:
- Plastic shell available in a selection of colors
 - Tubular steel frame finished in Polished Chrome
 - Stainless steel self-leveling glides

- Optional Features:
- Stainless steel self-leveling glides with felt
 - Chair trolley(CF Trolley): MX1005BL

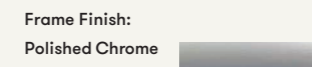

For larger swatches go to pg.188-205



↓ Scan here to discover more



↓ Scan here to discover more

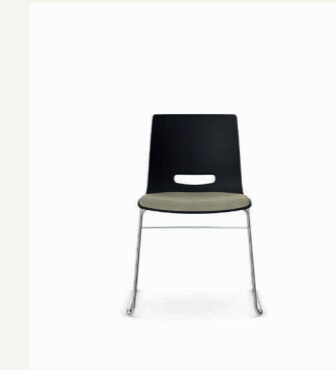

Casper - CS3
Side chair on a skid frame with upholstered seat pad

Dimensions:
 Seat Height 18.5"
 Seat Width 18"
 Seat Depth 17.25"
 Overall Height 32"
 Overall Width 22"
 Overall Depth 21.75"

- Standard Features:
- Plastic shell available in a selection of colors
 - Wire frame finished in Polished Chrome
 - Plastic glides
 - Upholstered seat pad
 - Stacks (on trolley) up to 21 high

- Optional Features:
- Detachable writing tablet
 - Plastic glides with felt
 - Ribbed upholstered seat pad (add P to product code)

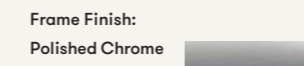
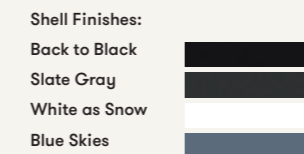

For larger swatches go to pg.188-205

Casper - CS4
Side chair on a 4 leg frame with upholstered seat pad

Dimensions:
 Seat Height 18.5"
 Seat Width 18"
 Seat Depth 17.25"
 Overall Height 32"
 Overall Width 21.75"
 Overall Depth 21.75"

- Standard Features:
- Plastic shell available in a selection of colors
 - Tubular steel frame finished in Polished Chrome
 - Stainless steel self-leveling glides
 - Upholstered seat pad
 - Stacks (on trolley) up to 15 high

- Optional Features:
- Detachable writing tablet
 - Stainless steel self-leveling glides with felt
 - Ribbed upholstered seat pad (add P to product code)

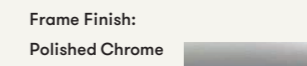
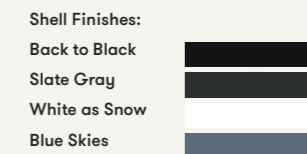

For larger swatches go to pg.188-205



Casper

Design by Allermuir Design Studio

18

19

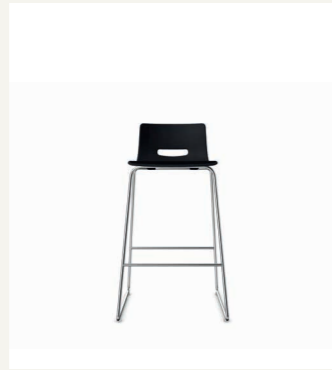
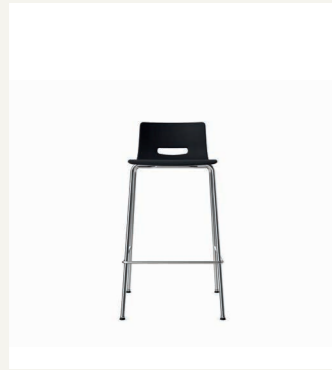

Casper - CS5BS
High stool on a 4 leg frame

Dimensions:

Seat Height	30"
Seat Width	16.25"
Seat Depth	16.5"
Overall Height	37.75"
Overall Width	20.75"
Overall Depth	20.5"



Standard Features:

- Plastic shell available in a selection of colors
- Tubular steel frame finished in Polished Chrome
- Stainless steel self-leveling glides

Optional Features:

- Stainless steel self-leveling glides with felt
- Counter height stool option, seat height 24.5" (add CH to product code)

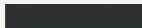
Shell Finishes:

Back to Black	
Slate Gray	
White as Snow	
Blue Skies	

Frame Finish:

Polished Chrome	
-----------------	---

For larger swatches go to pg.188-205

Casper - CS9BS
High stool on a skid frame

Dimensions:

Seat Height	30"
Seat Width	16.25"
Seat Depth	16.5"
Overall Height	37.75"
Overall Width	20.75"
Overall Depth	20.5"



Standard Features:

- Plastic shell available in a selection of colors
- Wire frame finished in Polished Chrome
- Plastic glides

Optional Features:

- Plastic glides with felt

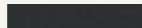
Shell Finishes:

Back to Black	
Slate Gray	
White as Snow	
Blue Skies	

Frame Finish:

Polished Chrome	
-----------------	---

For larger swatches go to pg.188-205



↓ Scan here to discover more



↓ Scan here to discover more



Casper

Design by Allermuir Design Studio

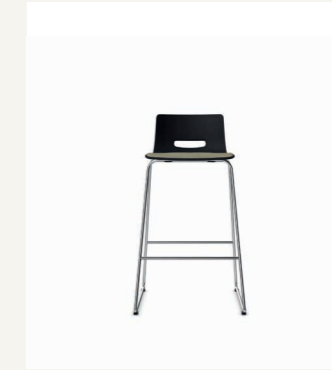
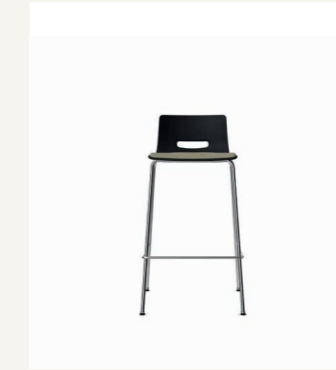

Casper - CS6BS
High stool on a 4 leg frame with upholstered seat pad

Dimensions:

Seat Height	30"
Seat Width	16.25"
Seat Depth	16.5"
Overall Height	37.75"
Overall Width	20.75"
Overall Depth	20.5"



Standard Features:

- Plastic shell available in a selection of colors
- Tubular steel frame finished in Polished Chrome
- Upholstered seat
- Stainless steel self-leveling glides

Optional Features:

- Plastic self-leveling glides with felt
- Counter height stool option, seat height 24.5" (add CH to product code)

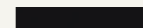
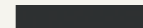
Shell Finishes:

Back to Black	
Slate Gray	
White as Snow	
Blue Skies	

Frame Finish:

Polished Chrome	
-----------------	---

For larger swatches go to pg.188-205

Casper - CS10BS
High stool on a skid frame with upholstered seat pad

Dimensions:

Seat Height	30"
Seat Width	16.25"
Seat Depth	16.5"
Overall Height	37.75"
Overall Width	20.75"
Overall Depth	20.5"



Standard Features:

- Plastic shell available in a selection of colors
- Wire frame finished in Polished Chrome
- Upholstered seat
- Plastic glides

Optional Features:

- Ribbed upholstered seat pad
- Plastic glides with felt
- Counter height stool option, seat height 24.5" (add CH to product code)

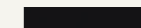
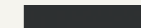
Shell Finishes:

Back to Black	
Slate Gray	
White as Snow	
Blue Skies	

Frame Finish:

Polished Chrome	
-----------------	---

For larger swatches go to pg.188-205



Crop

Design by Benjamin Hubert | Layer

20

21

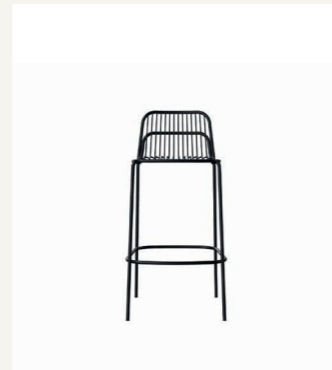
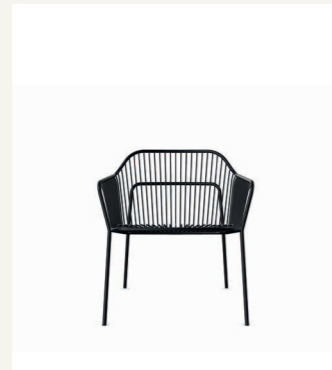

Crop - CRP02
Armchair

Dimensions:

Seat Height	19"
Seat Width	19.25"
Seat Depth	17.25"
Overall Height	32.75"
Overall Width	24.5"
Overall Depth	21.5"

Standard Features:

- Steel wire frame finished in Black (Textured) powder coat for outdoor use
- Plastic stacking buffers
- Plastic glides
- Stacks up to 4 high

Optional Features:

- Steel wire frame available in a selection of powder coat finishes

Frame Finishes:

Black (Textured)	
Teal	
Blush	
Ivory	
Pastel Green	
Olive	

Seat Pad Upholstery:

Kvadrat Patio 170	
Kvadrat Patio 230	
Kvadrat Patio 340	
Kvadrat Patio 740	
Kvadrat patio 840	
Agua Aura Ebony	
Agua Aura Turquoise	
Agua Aura Copper	
Agua Aura Forest	
Agua Aura Mink	
Agua Aura Nimbus	

For larger swatches go to pg.188-205



Crop - CRP03
Lounge chair

Dimensions:

Seat Height	16.5"
Seat Width	20"
Seat Depth	19.25"
Overall Height	28.75"
Overall Width	26.5"
Overall Depth	26.5"

Standard Features:

- Steel wire frame finished in Black (Textured) powder coat for outdoor use
- Plastic glides

Optional Features:

- Steel wire frame available in a selection of powder coat finishes

Frame Finishes:

Black (Textured)	
Teal	
Blush	
Ivory	
Pastel Green	
Olive	

Seat Pad Upholstery:

Kvadrat Patio 170	
Kvadrat Patio 230	
Kvadrat Patio 340	
Kvadrat patio 740	
Kvadrat patio 840	
Agua Aura Ebony	
Agua Aura Turquoise	
Agua Aura Copper	
Agua Aura Forest	
Agua Aura Mink	
Agua Aura Nimbus	

For larger swatches go to pg.188-205



Crop - CRP05
High back stool

Dimensions:

Seat Height	30.75"
Seat Width	16.75"
Seat Depth	15.25"
Overall Height	40"
Overall Width	18.75"
Overall Depth	20"

Standard Features:

- Steel wire frame finished in Black (Textured) powder coat for outdoor use
- Plastic glides

Optional Features:

- Steel wire frame available in a selection of powder coat finishes
- Counter height stool option, seat height 24.5" (add CH to product code)

Frame Finishes:

Black (Textured)	
Teal	
Blush	
Ivory	
Pastel Green	
Olive	

Seat Pad Upholstery:

Kvadrat Patio 170	
Kvadrat Patio 230	
Kvadrat Patio 340	
Kvadrat Patio 740	
Kvadrat patio 840	
Agua Aura Ebony	
Agua Aura Turquoise	
Agua Aura Copper	
Agua Aura Forest	
Agua Aura Mink	
Agua Aura Nimbus	

For larger swatches go to pg.188-205



↓ Scan here to discover more



Famiglia

Design by Pearson Lloyd

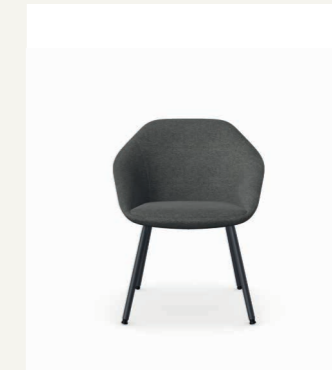
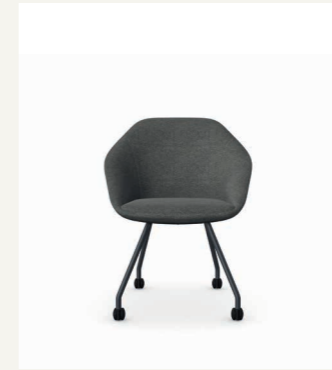

Famiglia - FMG-1101
Low back on a 4 leg frame with casters

Dimensions:

Seat Height	18.75"
Seat Width	17.75"
Seat Depth	17.75"
Overall Height	32.5"
Overall Width	25.25"
Overall Depth	23.5"

Standard Features:

- Molded foam construction
- Fully Upholstered
- Tubular Steel Frame on 2" hard wheel casters finished in New Black powder coat

Optional Features:

- Tubular Steel frame available in a selection of powder coat finishes
- 2" soft wheels casters
- Two-tone Upholstery

Frame Finishes:

New Black	
White	
Soft Gold	
Soft Silver	
Dark Bronze	
Deep Mulberry	

For larger swatches go to pg.188-205



Famiglia - FMG-1102
Low back chair on a 4 leg frame

Dimensions:

Seat Height	17.75"
Seat Width	17.75"
Seat Depth	17.75"
Overall Height	31.5"
Overall Width	25.25"
Overall Depth	23.5"

Standard Features:

- Molded foam construction
- Fully Upholstered
- Tubular Steel Frame finished in New Black powder coat
- Plastic Glides

Optional Features:

- Tubular Steel frame available in a selection of powder coat finishes
- Plastic Glides with felt
- Two-tone Upholstery

Frame Finishes:

New Black	
White	
Soft Gold	
Soft Silver	
Dark Bronze	
Deep Mulberry	

For larger swatches go to pg.188-205



Famiglia - FMG-1103
Low back chair on wood legs

Dimensions:

Seat Height	18"
Seat Width	17.75"
Seat Depth	17.75"
Overall Height	32"
Overall Width	25.25"
Overall Depth	23.5"

Standard Features:

- Molded foam construction
- Fully Upholstered
- Aluminum leg connector frame finished in New Black powder coat
- Solid Ash legs with a clear finish
- Plastic Glides

Optional Features:

- Solid Ash legs can be stained or color washed
- Plastic Glides with felt
- Two-tone Upholstery

Frame Finish:

New Black	
Wood Stains based on Ash:	
Clear	
White Oak	
American Cherry	
American Walnut	
Dark Walnut	
Wenge	

For larger swatches go to pg.188-205

16 optional standard color washes based on Ash are also available please go to pg.194 to see more.



↓ Scan here to discover more



Famiglia

Design by Pearson Lloyd

22

23

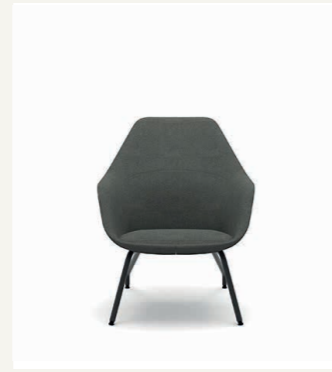

Famiglia - FMG1105
Low back chair on 4 star base glides

Dimensions:

Seat Height	18.25"
Seat Width	17.75"
Seat Depth	17.75"
Overall Height	32"
Overall Width	25.25"
Overall Depth	23.5"

- Standard Features:
- Molded foam construction
 - Fully Upholstered
 - 4 star Aluminum swivel base on glides finished in New Black powder coat
 - Plastic Glides

- Optional Features:
- Aluminum base available in a selection of powder coat finishes
 - 4 star auto return base on glides
 - Plastic Glides with felt
 - Two-tone Upholstery

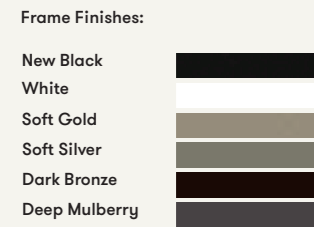

For larger swatches go to pg.188-205

Famiglia - FMG1106
Low back chair on a 5 star base with casters

Dimensions:

Seat Height	20.25"
Seat Width	17.75"
Seat Depth	17.75"
Overall Height	33.75"
Overall Width	25.75"
Overall Depth	23.5"

- Standard Features:
- Molded foam construction
 - Fully Upholstered
 - 5 star Aluminum swivel base with height adjustment on 2" hard wheel casters finished in New Black powder coat

- Optional Features:
- Aluminum base available in a selection of powder coat finishes
 - 2" soft wheel casters
 - Two-tone Upholstery

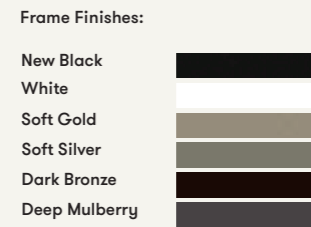

For larger swatches go to pg.188-205

Famiglia - FMG1201
Mid back on a recliner frame

Dimensions:

Seat Height	15.25"
Seat Width	18.5"
Seat Depth	19"
Overall Height	33"
Overall Width	26.25"
Overall Depth	28.25"

- Standard Features:
- Molded foam construction with dual density back foam
 - Fully Upholstered
 - Tubular Steel reclined frame finished in New Black powder coat
 - Plastic Glides

- Optional Features:
- Tubular Steel frame available in a selection of powder coat finishes
 - Plastic Glides with felt
 - Two-tone Upholstery



For larger swatches go to pg.188-205

Famiglia

Design by Pearson Lloyd



Famiglia - FMG1202
Mid back chair on a 4 leg frame

Dimensions:

Seat Height	20.25"
Seat Width	20.5"
Seat Depth	22.25"
Overall Height	38.5"
Overall Width	26.25"
Overall Depth	30.5"

- Standard Features:
- Molded foam construction with dual density back foam
 - Fully Upholstered
 - Tubular Steel frame finished in New Black powder coat
 - Plastic Glides

- Optional Features:
- Tubular Steel frame available in a selection of powder coat finishes
 - Plastic Glides with felt
 - Two-tone Upholstery

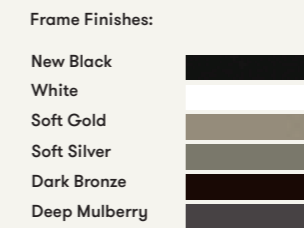

For larger swatches go to pg.188-205

Famiglia - FMG1203
Mid back chair on wood legs

Dimensions:

Seat Height	14.75"
Seat Width	18.5"
Seat Depth	18.75"
Overall Height	32"
Overall Width	26.25"
Overall Depth	28.75"

- Standard Features:
- Molded foam construction with dual density back foam
 - Fully Upholstered
 - Solid Ash legs with a clear finish
 - Plastic Glides

- Optional Features:
- Solid Ash legs can be stained or color washed
 - Plastic Glides with felt
 - Two-tone upholstery



For larger swatches go to pg.188-205

16 optional standard color washes based on Ash are also available please go to pg.194 to see more.

Famiglia - FMG1206
Mid back chair on a 5 star base with casters

Dimensions:

Seat Height	19.75"
Seat Width	18.5"
Seat Depth	19.25"
Overall Height	40"
Overall Width	28"
Overall Depth	26.75"

- Standard Features:
- Molded foam construction with dual density back foam
 - Fully Upholstered
 - 5 star plastic base finished in Black
 - Dynamic free-floating recline and forward tilt with height adjustment
 - 2.5" hard wheel casters

- Optional Features:
- 5 star Aluminum swivel base in Polished Aluminum
 - 2.5" soft wheel casters
 - Two-tone Upholstery

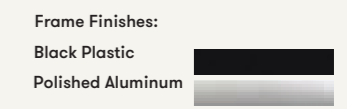

For larger swatches go to pg.188-205

↓ Scan here to discover more



↓ Scan here to discover more



Famiglia

Design by Pearson Lloyd

24

25



Famiglia - FMG1401
Lounge Chair on wire frame

Dimensions:
 Seat Height 16.25"
 Seat Width 21.5"
 Seat Depth 22"
 Overall Height 43"
 Overall Width 34.75"
 Overall Depth 33.5"

- Standard Features:
- Molded foam construction with dual density back foam
 - Fully Upholstered
 - Tubular Steel frame finished in New Black powder coat
 - Plastic glides

- Optional Features:
- Tubular Steel frame available in a selection of powder coat finishes
 - Plastic Glides with felt
 - Two-tone Upholstery



For larger swatches go to pg.188-205

Famiglia - FMG1403
Lounge Chair on wooden frame

Dimensions:
 Seat Height 16.25"
 Seat Width 21.5"
 Seat Depth 22"
 Overall Height 42.5"
 Overall Width 34.75"
 Overall Depth 33.5"

- Standard Features:
- Molded foam construction with dual density back foam
 - Fully Upholstered
 - Solid Ash legs with a clear finish
 - Plastic glides

- Optional Features:
- Solid Ash legs can be stained or color washed
 - Plastic Glides with felt
 - Two-tone upholstery

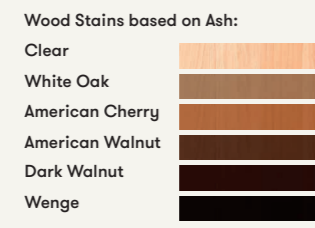

For larger swatches go to pg.188-205

16 optional standard color washes based on Ash are also available please go to pg.194 to see more.

Famiglia - FMG1405
Lounge chair on a 4 star swivel blade base

Dimensions:
 Seat Height 16.75"
 Seat Width 21.5"
 Seat Depth 22"
 Overall Height 43.25"
 Overall Width 34.75"
 Overall Depth 35.75"

- Standard Features:
- Molded foam construction with dual density back foam
 - Fully Upholstered
 - 4 Star Aluminum auto return swivel base in New Black powder coat
 - Plastic glides

- Optional Features:
- 4 Star Aluminum auto return swivel available in a selection of powder coat finishes
 - 4 Star Aluminum auto return swivel available in Polished Aluminum
 - Two-tone upholstery

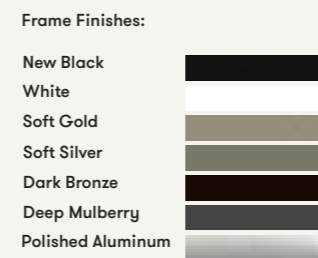

For larger swatches go to pg.188-205



↓ Scan here to discover more



↓ Scan here to discover more



Famiglia

Design by Pearson Lloyd

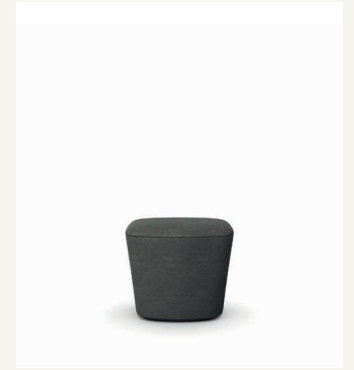

Famiglia - FMG1501
High back on reclining frame

Dimensions:
 Seat Height 15.75"
 Seat Width 19.50"
 Seat Depth 20.75"
 Overall Height 46.25"
 Overall Width 29.5"
 Overall Depth 32.75"

- Standard Features:
- Molded foam construction with dual density back foam
 - Fully Upholstered
 - Tubular Steel reclined frame finished in New Black powder coat
 - Plastic Glides

- Optional Features:
- Tubular Steel frame available in a selection of powder coat finishes
 - Plastic glides with felt
 - Two-tone upholstery

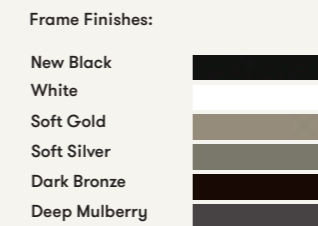

For larger swatches go to pg.188-205

Famiglia - FMG1505
High back on 4 star swivel base

Dimensions:
 Seat Height 16.25"
 Seat Width 19.50"
 Seat Depth 20.75"
 Overall Height 47"
 Overall Width 34"
 Overall Depth 35.50"

- Standard Features:
- Molded foam construction with dual density back foam
 - Fully Upholstered
 - 4 star Aluminum auto return swivel base finished in New Black powder coat
 - Plastic Glides

- Optional Features:
- 4 star Aluminum auto return swivel base available in a selection of powder coat finishes.
 - 4 star Aluminum auto return swivel base available in Polished Aluminum
 - Plastic glides with felt
 - Two-tone upholstery

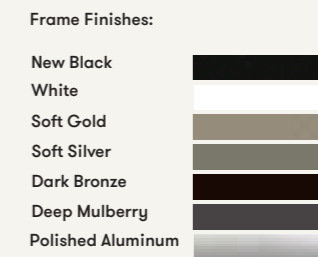

For larger swatches go to pg.188-205

Famiglia - FMGFS
Footstool

Dimensions:
 Seat Height 17"
 Seat Width 20"
 Seat Depth 17.25"
 Overall Height 17"
 Overall Width 20"
 Overall Depth 17.25"

- Standard Features:
- Molded foam construction
 - Fully Upholstered

- Optional Features:
- Two-tone upholstery



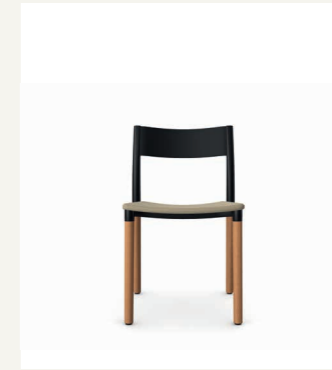
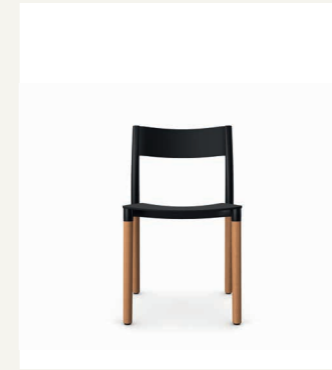
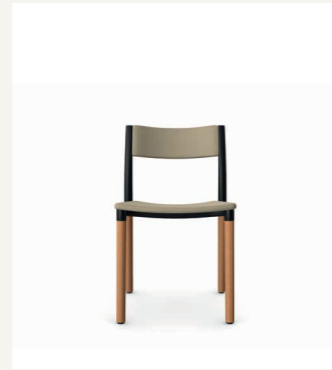
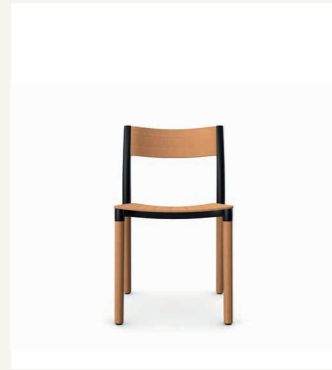

Folk - FLK101
Chair with wood seat and back

Dimensions:

Seat Height	17.25"
Seat Width	18"
Seat Depth	17.25"
Overall Height	31"
Overall Width	18.75"
Overall Depth	20"

- Standard Features:**
- Cast Aluminum frame in Off Black powder coat with Beech ply seat, back and legs in a clear finish
 - Plastic glides
 - Stacks up to 4 high

- Optional Features:**
- Cast Aluminum frame available in a selection of powder coat finishes
 - Beech ply seat, back and solid Beech legs can be stained or color washed
 - Oak ply seat, back and solid Oak legs with a clear finish
 - Plastic glides with felt

Frame Finishes:

Off Black	
White	
Crayon Gray	
Pistachio	
Seattle Green	
Aubergine	

Solid Wood Finishes:

Clear on Beech	
Clear on Oak	

For larger swatches go to pg.188-205

6 optional Wood Stains and 8 color washes based on Beech are also available please go to pg.193 and 195 to see more.

Folk - FLK101U1
Chair with wood back and upholstered seat

Dimensions:

Seat Height	17.25"
Seat Width	18"
Seat Depth	17.25"
Overall Height	31"
Overall Width	18.75"
Overall Depth	20"

- Standard Features:**
- Upholstered seat
 - Cast Aluminum frame in Off Black powder coat with Beech ply back and legs in a clear finish
 - Plastic glides
 - Stacks up to 4 high

- Optional Features:**
- Cast Aluminum frame available in a selection of powder coat finishes
 - Beech ply back and solid Beech legs can be stained or color washed
 - Oak ply back and solid Oak legs with a clear finish
 - Plastic glides with felt

Frame Finishes:

Off Black	
White	
Crayon Gray	
Pistachio	
Seattle Green	
Aubergine	

Solid Wood Finishes:

Clear on Beech	
Clear on Oak	

For larger swatches go to pg.188-205

6 optional Wood Stains and 8 color washes based on Beech are also available please go to pg.193 and 195 to see more.

Folk - FLK100U3
Chair with upholstered seat and back

Dimensions:

Seat Height	17.25"
Seat Width	18"
Seat Depth	17.25"
Overall Height	31"
Overall Width	18.75"
Overall Depth	20"

- Standard Features:**
- Upholstered seat and back
 - Cast Aluminum frame in Off Black powder coat with Beech ply legs in a clear finish
 - Plastic glides
 - Stacks up to 4 high

- Optional Features:**
- Cast Aluminum frame available in a selection of powder coat finishes
 - Solid Beech legs can be stained or color washed
 - Solid Oak legs with a clear finish
 - Plastic glides with felt
 - Two-tone upholstery

Frame Finishes:

Off Black	
White	
Crayon Gray	
Pistachio	
Seattle Green	
Aubergine	

Solid Wood Finishes:

Clear on Beech	
Clear on Oak	

For larger swatches go to pg.188-205

6 optional Wood Stains and 8 color washes based on Beech are also available please go to pg.193 and 195 to see more.



↓ Scan here to discover more



↓ Scan here to discover more



Folk - FLK103
Chair with plastic seat and back

Dimensions:

Seat Height	17.25"
Seat Width	18"
Seat Depth	17.25"
Overall Height	31"
Overall Width	18.75"
Overall Depth	20"

- Standard Features:**
- Upholstered Back
 - Off Black plastic seat, back and Aluminum frame with Clear Beech legs as standard
 - Plastic glides
 - Stacks up to 4 high

- Optional Features:**
- Cast Aluminum frame and plastic seat and back available in a selection of powder coat finishes
 - Solid Beech legs can be stained or color washed
 - Solid Oak legs with a clear finish
 - Plastic glides with felt

Frame / Plastic Finishes:

Off Black	
White	
Crayon Gray	
Pistachio	
Seattle Green	
Aubergine	

Solid Wood Finishes:

Clear on Beech	
Clear on Oak	

For larger swatches go to pg.188-205

6 optional Wood Stains and 8 color washes based on Beech are also available please go to pg.193 and 195 to see more.

Folk - FLK103U1
Chair with plastic back and upholstered seat

Dimensions:

Seat Height	17.25"
Seat Width	18"
Seat Depth	17.25"
Overall Height	31"
Overall Width	18.75"
Overall Depth	20"

- Standard Features:**
- Off Black plastic back and Aluminum frame with Clear Beech legs as standard
 - Upholstered Seat
 - Plastic glides
 - Stacks up to 4 high

- Optional Features:**
- Cast Aluminum frame and plastic back available in a selection of powder coat finishes
 - Solid Beech legs can be stained or color washed
 - Solid Oak legs with a clear finish
 - Plastic glides with felt

Frame / Plastic Finishes:

Off Black	
White	
Crayon Gray	
Pistachio	
Seattle Green	
Aubergine	

Solid Wood Finishes:

Clear on Beech	
Clear on Oak	

For larger swatches go to pg.188-205

6 optional Wood Stains and 8 color washes based on Beech are also available please go to pg.193 and 195 to see more.

Folk

Design by Pearson Lloyd

28

29

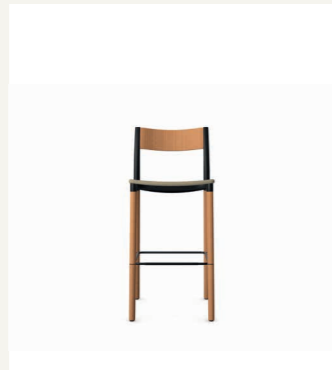
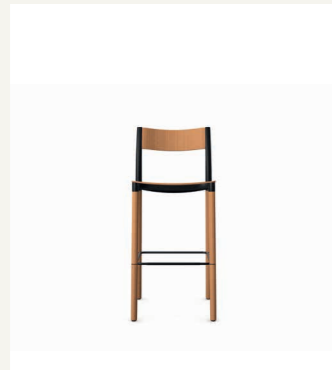

Folk - FLK301
Stool with wood seat and back

Dimensions:
 Seat Height 29.75"
 Seat Width 18"
 Seat Depth 17.25"
 Overall Height 43.25"
 Overall Width 19"
 Overall Depth 20.5"

- Standard Features:**
- Off Black Aluminum frame with Clear Beech back, seat and legs as standard
 - Footrest finished in Off Black powder coat
 - Footrest protector
 - Plastic glides

- Optional Features:**
- Counter height stool option, seat height 24.5" (add CH to product code)
 - Cast Aluminum frame available in a selection of powder coat finishes
 - Beech ply seat, back and solid Beech legs can be stained or color washed
 - Oak ply seat, back and solid Oak legs with a clear finish
 - Plastic glides with felt

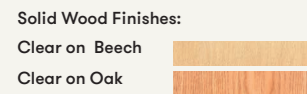
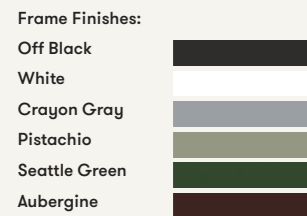

For larger swatches go to pg.188-205

6 optional Wood Stains and 8 color washes based on Beech are also available please go to pg.193 and 195 to see more.

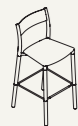

Folk - FLK301U1
Stool with wood back and upholstered seat

Dimensions:
 Seat Height 29.75"
 Seat Width 18"
 Seat Depth 17.25"
 Overall Height 43.25"
 Overall Width 19"
 Overall Depth 20.5"

- Standard Features:**
- Off Black Aluminum frame with Clear Beech back and legs as standard
 - Footrest finished in Off Black powder coat
 - Upholstered Seat
 - Footrest protector
 - Plastic glides

- Optional Features:**
- Cast Aluminum frame available in a selection of powder coat finishes
 - Beech ply back and solid Beech legs can be stained or color washed
 - Oak ply back and solid Oak legs with a clear finish
 - Plastic glides with felt

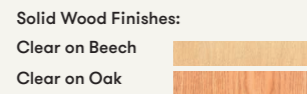
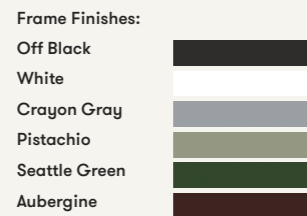

For larger swatches go to pg.188-205

6 optional Wood Stains and 8 color washes based on Beech are also available please go to pg.193 and 195 to see more.

↓ Scan here to discover more



↓ Scan here to discover more



Folk

Design by Pearson Lloyd

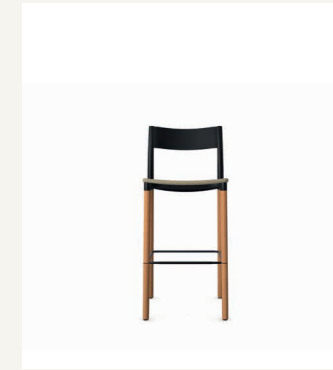
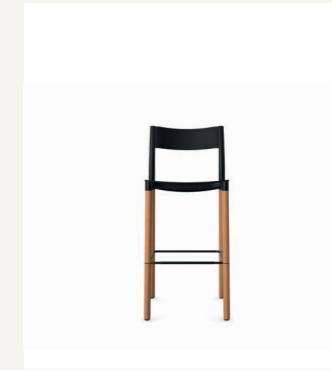
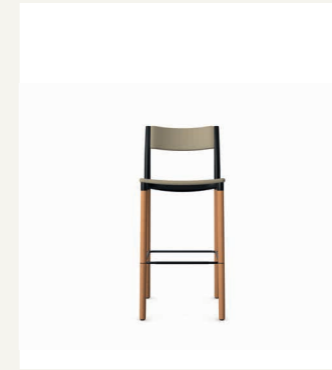

Folk - FLK300U3
Stool with upholstered seat and back

Dimensions:
 Seat Height 29.75"
 Seat Width 18"
 Seat Depth 17.25"
 Overall Height 43.25"
 Overall Width 19"
 Overall Depth 20.5"

- Standard Features:**
- Off Black Aluminum frame with Clear Beech legs as standard
 - Upholstered seat and back
 - Footrest finished in Off Black powder coat
 - Footrest protector
 - Plastic glides

- Optional Features:**
- Cast Aluminum frame available in a selection of powder coat finishes
 - Solid Beech legs can be stained or color washed
 - Solid Oak legs with a clear finish
 - Plastic glides with felt
 - Two-tone upholstery

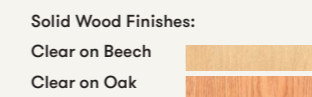
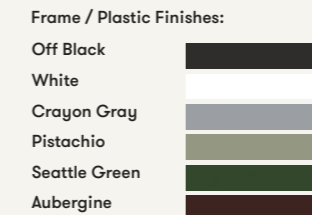

For larger swatches go to pg.188-205

6 optional Wood Stains and 8 color washes based on Beech are also available please go to pg.193 and 195 to see more.



Folk - FLK303
Stool with plastic seat and back

Dimensions:
 Seat Height 29.75"
 Seat Width 18"
 Seat Depth 17.25"
 Overall Height 43.25"
 Overall Width 19"
 Overall Depth 20.5"

- Standard Features:**
- Off Black plastic seat, back and Aluminum frame with Clear Beech legs as standard
 - Footrest finished in Off Black powder coat
 - Footrest protector
 - Plastic glides

- Optional Features:**
- Counter height stool option, seat height 24.5" (add CH to product code)
 - Plastic seat, back and Aluminum frame available in a selection of powder coat finishes
 - Solid Beech legs can be stained or color washed
 - Solid Oak legs with a clear finish
 - Plastic glides with felt

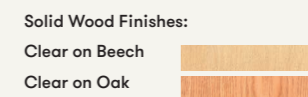
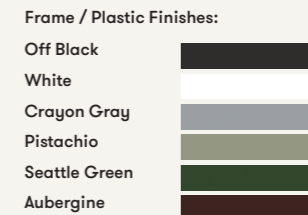

For larger swatches go to pg.188-205

6 optional Wood Stains and 8 color washes based on Beech are also available please go to pg.193 and 195 to see more.

Folk - FLK303U1
Stool with plastic back and upholstered seat

Dimensions:
 Seat Height 29.75"
 Seat Width 18"
 Seat Depth 17.25"
 Overall Height 43.25"
 Overall Width 19"
 Overall Depth 20.5"

- Standard Features:**
- Off Black plastic back and Aluminum frame with Clear Beech legs as standard
 - Footrest finished in Off Black powder coat
 - Upholstered Seat
 - Footrest protector
 - Plastic glides

- Optional Features:**
- Counter height stool option, seat height 24.5" (add CH to product code)
 - Plastic back and Aluminum frame available in a selection of powder coat finishes
 - Solid Beech legs can be stained or color washed
 - Solid Oak legs with a clear finish
 - Plastic glides with felt

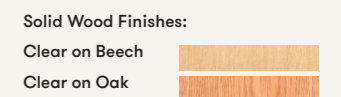
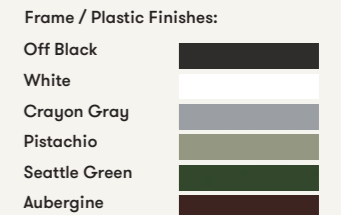

For larger swatches go to pg.188-205

6 optional Wood Stains and 8 color washes based on Beech are also available please go to pg.193 and 195 to see more.

Jojo

Design By Foersom & Hiort-Lorenzen

30

31

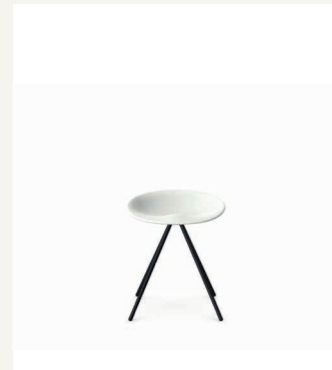
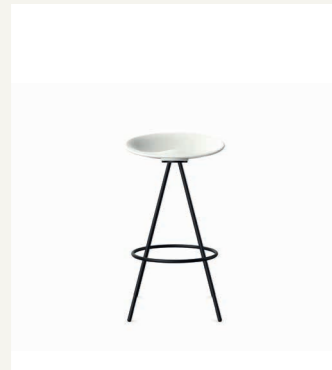

Jojo - A596
High stool

Dimensions:
 Seat Height 29.75"
 Seat Width 15"
 Seat Depth 15"
 Overall Height 34.5"
 Overall Width 19"
 Overall Depth 17"

- Standard Features:
- Rigid PU shell finished in Pure White
 - Tubular Steel frame finished in Polished Chrome powder coat
 - Plastic glides

- Optional Features:
- Polished Chrome frame
 - Counter height stool option, seat height 24.5" (add CH to product code)

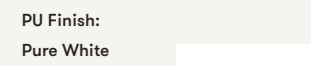
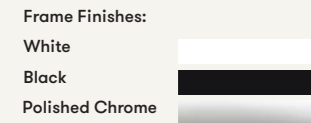

For larger swatches go to pg.188-205

Jojo - A597
Low stool

Dimensions:
 Seat Height 18.25"
 Seat Width 15"
 Seat Depth 15"
 Overall Height 22.75"
 Overall Width 19"
 Overall Depth 17"

- Standard Features:
- Rigid PU shell finished in Pure White
 - Tubular Steel frame finished in Polished Chrome powder coat
 - Plastic glides

- Optional Features:
- Polished Chrome frame

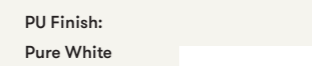
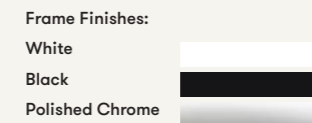

For larger swatches go to pg.188-205



↓ Scan here to discover more



↓ Scan here to discover more



Kin

Design by Pearson Lloyd

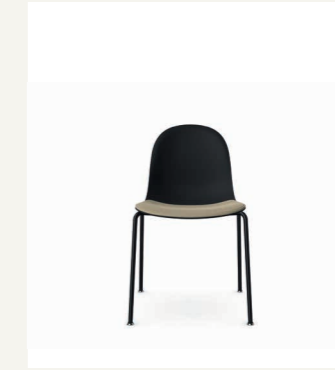
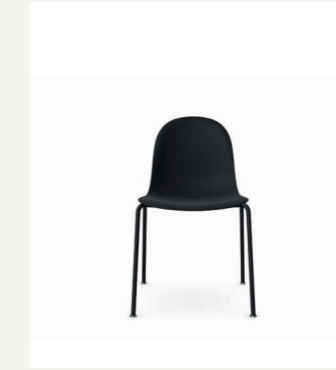

Kin - KIN102
Side chair on 4 leg frame

Dimensions:
 Seat Height 17.75"
 Seat Width 18"
 Seat Depth 21"
 Overall Height 32.25"
 Overall Width 20.50"
 Overall Depth 21"

- Standard Features:
- Plastic shell finished in Off Black
 - Tubular steel frame finished in Off Black powder coat
 - Plastic glides
 - Stacks up to 4 high

- Optional Features:
- Plastic shell available in a selection of colors with complementary powder coat base or frame
 - Plastic glides with felt



For larger swatches go to pg.188-205

Kin - KIN102U1
Side chair with upholstered seat on 4 leg frame

Dimensions:
 Seat Height 17.75"
 Seat Width 18"
 Seat Depth 21"
 Overall Height 32.25"
 Overall Width 20.50"
 Overall Depth 21"

- Standard Features:
- Plastic shell finished in Off Black
 - Upholstered seat pad
 - Tubular steel frame finished in Off Black powder coat
 - Plastic glides
 - Stacks up to 4 high

- Optional Features:
- Plastic shell available in a selection of colors with complementary powder coat base or frame
 - Plastic glides with felt



For larger swatches go to pg.188-205

Kin - KIN102U3
Side chair fully upholstered on 4 leg frame

Dimensions:
 Seat Height 17.75"
 Seat Width 18"
 Seat Depth 21"
 Overall Height 32.25"
 Overall Width 20.50"
 Overall Depth 21"

- Standard Features:
- Fully upholstered shell
 - Tubular Steel frame finished in Off Black powder coat
 - Plastic glides
 - Stacks up to 4 high

- Optional Features:
- Plastic glides with felt
 - Two-tone upholstery



For larger swatches go to pg.188-205



Kin

Design by Pearson Lloyd

32

33

Kin

Design by Pearson Lloyd



Kin - KIN103
Side chair on wood legs

Dimensions:
 Seat Height 17.25"
 Seat Width 18"
 Seat Depth 21"
 Overall Height 32"
 Overall Width 18"
 Overall Depth 21"

- Standard Features:**
- Plastic shell finished in Off Black
 - Aluminum leg connector frame finished in Off Black powder coat
 - Solid Ash legs with a clear finish
 - Plastic glides

- Optional Features:**
- Plastic shell available in a selection of colors with complementary powder coat leg connector frame
 - Solid Ash legs can be stained or color matched to complement shell
 - Plastic glides with felt

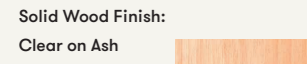

For larger swatches go to pg.188-205

6 optional Wood Stains and 8 color washes based on Ash are also available please go to pg.193 and 195 to see more.



Kin - KIN103U1
Side chair with upholstered seat on 4 wood legs

Dimensions:
 Seat Height 17.25"
 Seat Width 18"
 Seat Depth 21"
 Overall Height 32"
 Overall Width 18"
 Overall Depth 21"

- Standard Features:**
- Plastic shell finished in Off Black
 - Upholstered seat pad
 - Aluminum leg connector frame finished in Off Black powder coat
 - Solid Ash legs with a clear finish
 - Plastic glides

- Optional Features:**
- Plastic shell available in a selection of colors with complementary powder coat leg connector frame
 - Solid Ash legs can be stained or color matched to complement shell
 - Plastic glides with felt

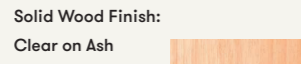

For larger swatches go to pg.188-205

6 optional Wood Stains and 8 color washes based on Ash are also available please go to pg.193 and 195 to see more.



Kin - KIN103U3
Side chair fully upholstered on wood legs

Dimensions:
 Seat Height 17.25"
 Seat Width 18"
 Seat Depth 21"
 Overall Height 32"
 Overall Width 18"
 Overall Depth 21"

- Standard Features:**
- Fully upholstered shell
 - Aluminum leg connector frame finished in Off Black powder coat
 - Solid Ash legs with a clear finish
 - Plastic glides

- Optional Features:**
- Solid Ash legs can be stained or color matched to complement shell
 - Plastic glides with felt
 - Two-tone upholstery

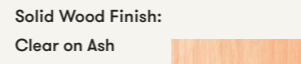

For larger swatches go to pg.188-205

6 optional Wood Stains and 8 color washes based on Ash are also available please go to pg.193 and 195 to see more.

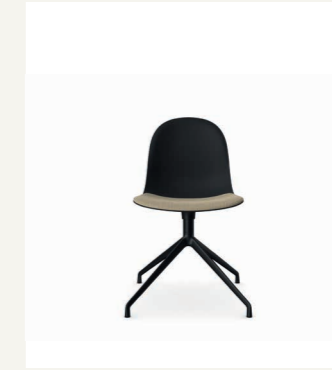
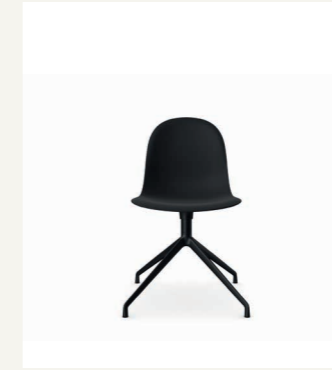

Kin - KIN104
Side chair on 4 star swivel base

Dimensions:
 Seat Height 17.25"
 Seat Width 18"
 Seat Depth 21"
 Overall Height 32"
 Overall Width 20.25"
 Overall Depth 21"

- Standard Features:**
- Plastic shell finished in Off Black
 - 4 star swivel base on glides finished in Off Black powder coat
 - Plastic glides

- Optional Features:**
- Plastic shell available in a selection of colors with complementary powder coat base or frame
 - 4 star auto return base on glides
 - 4 star fixed base on 2" hard wheel casters
 - Plastic glides with felt



For larger swatches go to pg.188-205



Kin - KIN104U1
Side chair with upholstered seat on 4 star swivel base

Dimensions:
 Seat Height 17.25"
 Seat Width 18"
 Seat Depth 21"
 Overall Height 32"
 Overall Width 20.25"
 Overall Depth 21"

- Standard Features:**
- Plastic shell finished in Off Black
 - Upholstered seat pad
 - 4 star swivel base on glides finished in Off Black powder coat
 - Plastic glides

- Optional Features:**
- Plastic shell available in a selection of colors with complementary powder coat base or frame
 - 4 star auto return base on glides
 - 4 star fixed base on 2" hard wheel casters
 - Plastic glides with felt



For larger swatches go to pg.188-205



Kin - KIN104U3
Side chair fully upholstered on 4 star swivel base

Dimensions:
 Seat Height 17.25"
 Seat Width 18"
 Seat Depth 21"
 Overall Height 32"
 Overall Width 20.25"
 Overall Depth 21"

- Standard Features:**
- Fully upholstered shell
 - 4 star swivel base on glides finished in Off Black powder coat
 - Plastic glides

- Optional Features:**
- 4 star auto return base on glides
 - 4 star fixed base on 2" hard wheel casters
 - Plastic glides with felt
 - Two-tone upholstery



For larger swatches go to pg.188-205



↓ Scan here to discover more



↓ Scan here to discover more



Kin

Design by Pearson Lloyd

34

35

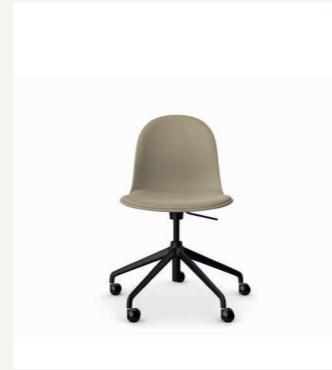
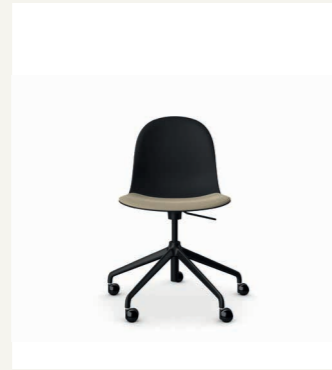
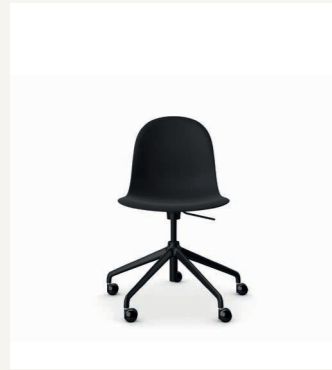

Kin - KIN105
Side chair on 5 star swivel base

Dimensions:
 Seat Height 15.5"-20.5"
 Seat Width 18"
 Seat Depth 21"
 Overall Height 30"-34.5"
 Overall Width 24.5"
 Overall Depth 23.5"

Standard Features:
 — Plastic shell finished in Off Black
 — 5 star swivel base with height adjustment on casters finished in Off Black powder coat
 — 2" hard wheel casters

Optional Features:
 — Plastic shell available in a selection of colors with complementary powder coat base or frame
 — Soft wheel casters



For larger swatches go to pg.188-205

Kin - KIN105U1
Side chair with upholstered seat on 5 star swivel base

Dimensions:
 Seat Height 15.5"-20.5"
 Seat Width 18"
 Seat Depth 21"
 Overall Height 30"-34.5"
 Overall Width 24.5"
 Overall Depth 23.5"

Standard Features:
 — Plastic shell finished in Off Black
 — Upholstered seat pad
 — 5 star swivel base with height adjustment on casters finished in Off Black powder coat
 — 2" hard wheel casters

Optional Features:
 — Plastic shell available in a selection of colors with complementary powder coat base or frame
 — Soft wheel casters



For larger swatches go to pg.188-205

Kin - KIN105U3
Side chair fully upholstered on 5 star swivel base

Dimensions:
 Seat Height 15.5"-20.5"
 Seat Width 18"
 Seat Depth 21"
 Overall Height 30"-34.5"
 Overall Width 24.5"
 Overall Depth 23.5"

Standard Features:
 — Fully upholstered shell
 — 5 star swivel base with height adjustment on casters finished in Off Black powder coat
 — 2" hard wheel casters

Optional Features:
 — Soft wheel casters
 — Two-tone upholstery



For larger swatches go to pg.188-205



↓ Scan here to discover more



↓ Scan here to discover more



Kin

Design by Pearson Lloyd

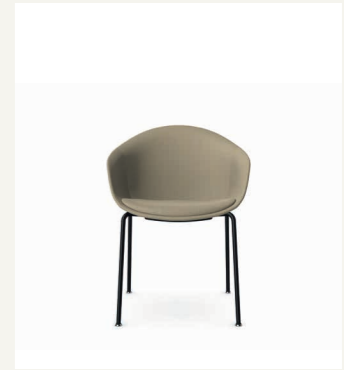
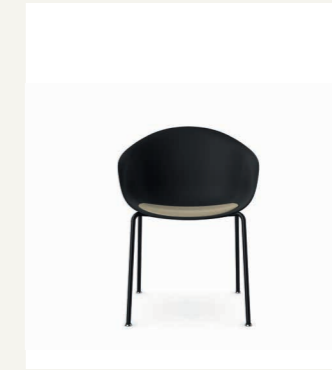
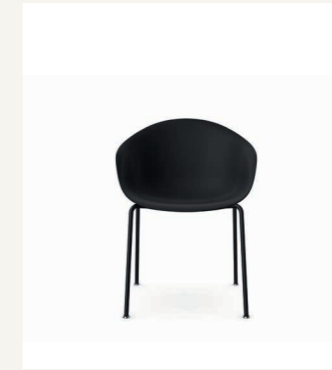

Kin - KIN302
Tub chair on 4 leg frame

Dimensions:
 Seat Height 17.75"
 Seat Width 19.25"
 Seat Depth 18.75"
 Overall Height 32.25"
 Overall Width 23.5"
 Overall Depth 22"

Standard Features:
 — Plastic shell finished in Off Black
 — Tubular steel frame finished in Off Black powder coat
 — Plastic glides

Optional Features:
 — Plastic shell available in a selection of colors with complementary powder coat base or frame
 — Plastic glides with felt



For larger swatches go to pg.188-205

Kin - KIN302U1
Tub chair with upholstered seat on 4 leg frame

Dimensions:
 Seat Height 17.75"
 Seat Width 19.25"
 Seat Depth 18.75"
 Overall Height 32.25"
 Overall Width 23.5"
 Overall Depth 22"

Standard Features:
 — Plastic shell finished in Off Black
 — Upholstered seat pad
 — Tubular steel frame finished in Off Black powder coat
 — Plastic glides

Optional Features:
 — Plastic shell available in a selection of colors with complementary powder coat base or frame
 — Plastic glides with felt



For larger swatches go to pg.188-205

Kin - KIN302U3
Tub chair fully upholstered on 4 leg frame

Dimensions:
 Seat Height 17.75"
 Seat Width 19.25"
 Seat Depth 18.75"
 Overall Height 32.25"
 Overall Width 23.5"
 Overall Depth 22"

Standard Features:
 — Fully upholstered shell
 — Tubular steel frame finished in Off Black powder coat
 — Plastic glides

Optional Features:
 — Plastic glides with felt
 — Two-tone upholstery



For larger swatches go to pg.188-205



Kin

Design by Pearson Lloyd

36

37

Kin

Design by Pearson Lloyd

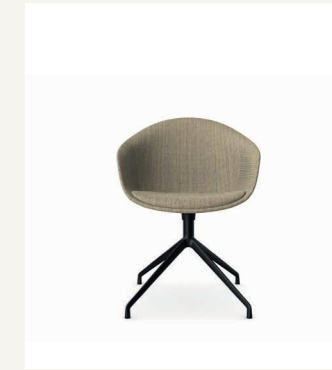
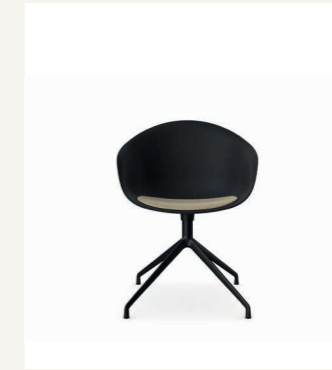
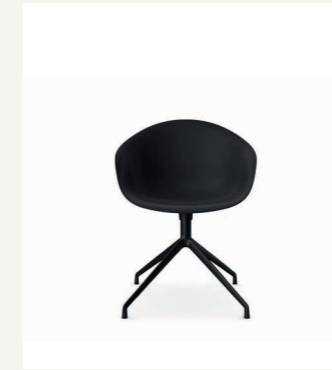
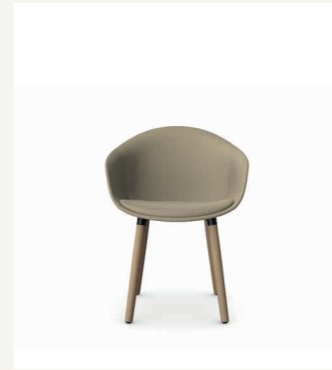
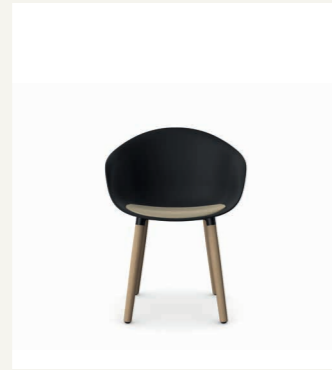

Kin - KIN303
Tub chair on wood legs

Dimensions:
 Seat Height 17.75"
 Seat Width 19.25"
 Seat Depth 18.75"
 Overall Height 32"
 Overall Width 23.5"
 Overall Depth 22"

- Standard Features:**
- Plastic shell finished in Off Black
 - Aluminum leg connector frame finished in Off Black powder coat
 - Solid Ash legs with a clear finish
 - Plastic glides

- Optional Features:**
- Plastic shell available in a selection of colors with complementary powder coat base or frame
 - Solid Ash legs can be stained or color matched to complement shell
 - Plastic glides with felt

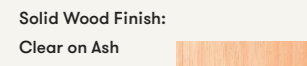

For larger swatches go to pg.188-205

6 optional Wood Stains and 8 color washes based on Ash are also available please go to pg.193 and 195 to see more.

Kin - KIN303U1
Tub chair with upholstered seat on wood legs

Dimensions:
 Seat Height 17.75"
 Seat Width 19.25"
 Seat Depth 18.75"
 Overall Height 32"
 Overall Width 23.5"
 Overall Depth 22"

- Standard Features:**
- Plastic shell finished in Off Black
 - Upholstered seat pad
 - Aluminum leg connector frame finished in Off Black powder coat
 - Solid Ash legs with a clear finish
 - Plastic glides

- Optional Features:**
- Plastic shell available in a selection of colors with complementary powder coat base or frame
 - Solid Ash legs can be stained or color matched to complement shell
 - Plastic glides with felt

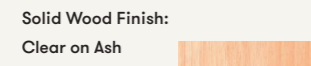

For larger swatches go to pg.188-205

6 optional Wood Stains and 8 color washes based on Ash are also available please go to pg.193 and 195 to see more.

Kin - KIN303U3
Tub chair fully upholstered on wood legs

Dimensions:
 Seat Height 17.75"
 Seat Width 19.25"
 Seat Depth 18.75"
 Overall Height 32"
 Overall Width 23.5"
 Overall Depth 22"

- Standard Features:**
- Fully upholstered shell
 - Aluminum leg connector frame finished in Off Black powder coat
 - Solid Ash legs with a clear finish
 - Plastic glides

- Optional Features:**
- Solid Ash legs can be stained or color matched to complement shell
 - Plastic glides with felt
 - Two-tone upholstery

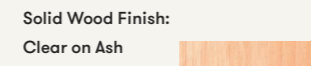

For larger swatches go to pg.188-205

6 optional Wood Stains and 8 color washes based on Ash are also available please go to pg.193 and 195 to see more.



↓ Scan here to discover more



↓ Scan here to discover more



Kin - KIN304
Tub chair on 4 star swivel base

Dimensions:
 Seat Height 17.75"
 Seat Width 19.25"
 Seat Depth 18.75"
 Overall Height 32"
 Overall Width 23.5"
 Overall Depth 22"

- Standard Features:**
- Plastic shell finished in Off Black
 - 4 star swivel base on glides finished in Off Black powder coat
 - Plastic glides

- Optional Features:**
- Plastic shell available in a selection of colors with complementary powder coat base or frame
 - 4 star auto return base on glides
 - 4 star fixed base on 2" hard wheel casters
 - Plastic glides with felt



For larger swatches go to pg.188-205

Kin - KIN304U1
Tub chair with upholstered seat on 4 star swivel base

Dimensions:
 Seat Height 17.75"
 Seat Width 19.25"
 Seat Depth 18.75"
 Overall Height 32"
 Overall Width 23.5"
 Overall Depth 22"

- Standard Features:**
- Plastic shell finished in Off Black
 - Upholstered seat pad
 - 4 star swivel base on glides finished in Off Black powder coat
 - Plastic glides

- Optional Features:**
- Plastic shell available in a selection of colors with complementary powder coat base or frame
 - 4 star auto return base on glides
 - 4 star fixed base on 2" hard wheel casters
 - Plastic glides with felt



For larger swatches go to pg.188-205

Kin - KIN304U3
Tub chair fully upholstered on 4 star swivel base

Dimensions:
 Seat Height 17.75"
 Seat Width 19.25"
 Seat Depth 18.75"
 Overall Height 32"
 Overall Width 23.5"
 Overall Depth 22"

- Standard Features:**
- Fully upholstered shell
 - 4 star swivel base on glides finished in Off Black powder coat
 - Plastic glides

- Optional Features:**
- 4 star auto return base on glides
 - 4 star fixed base on 2" hard wheel casters
 - Plastic glides with felt
 - Two-tone upholstery



For larger swatches go to pg.188-205



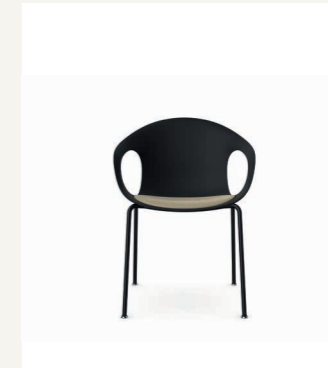
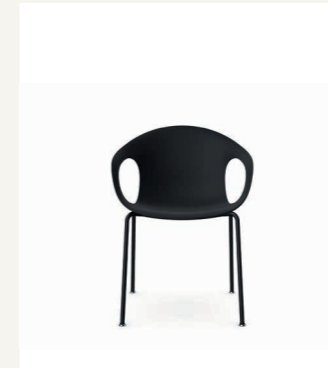

Kin - KIN305
Tub chair on 5 star swivel base

Dimensions:

Seat Height	15.5"-20.5"
Seat Width	19.25"
Seat Depth	18.75"
Overall Height	30"-34.5"
Overall Width	24.5"
Overall Depth	24"

- Standard Features:
- Plastic shell finished in Off Black
 - 5 star swivel base with height adjustment on casters finished in Off Black powder coat
 - 2" hard wheel casters

- Optional Features:
- Plastic shell available in a selection of colors with complementary powder coat base or frame
 - Plastic glides with felt

Frame and Shell Finishes:

Off Black	
White	
Crayon Gray	
Pistachio	
Seattle Green	
Aubergine	
Red	
Haze Blue	

For larger swatches go to pg.188-205

Kin - KIN305U1
Tub chair with upholstered seat on 5 star swivel base

Dimensions:

Seat Height	15.5"-20.5"
Seat Width	19.25"
Seat Depth	18.75"
Overall Height	30"-34.5"
Overall Width	24.5"
Overall Depth	24"

- Standard Features:
- Plastic shell finished in Off Black
 - Upholstered seat pad
 - 5 star swivel base with height adjustment on casters finished in Off Black powder coat
 - 2" hard wheel casters

- Optional Features:
- Plastic shell available in a selection of colors with complementary powder coat base or frame
 - Soft wheel casters

Frame and Shell Finishes:

Off Black	
White	
Crayon Gray	
Pistachio	
Seattle Green	
Aubergine	
Red	
Haze Blue	

For larger swatches go to pg.188-205

Kin - KIN305U3
Tub chair fully upholstered on 5 star swivel base

Dimensions:

Seat Height	15.5"-20.5"
Seat Width	19.25"
Seat Depth	18.75"
Overall Height	30"-34.5"
Overall Width	24.5"
Overall Depth	24"

- Standard Features:
- Fully upholstered shell
 - 5 star swivel base with height adjustment on casters finished in Off Black powder coat
 - 2" hard wheel casters

- Optional Features:
- Soft wheel casters
 - Two-tone upholstery

Frame and Shell Finishes:

Off Black	
White	
Crayon Gray	
Pistachio	
Seattle Green	
Aubergine	
Red	
Haze Blue	

For larger swatches go to pg.188-205

Kin - KIN202
Arm chair on 4 leg frame

Dimensions:

Seat Height	17.75"
Seat Width	19.25"
Seat Depth	18.75"
Overall Height	32.25"
Overall Width	23.5"
Overall Depth	22"

- Standard Features:
- Plastic shell finished in Off Black
 - Tubular steel frame finished in Off Black powder coat
 - Plastic glides
 - Stacks up to 4 high

- Optional Features:
- Plastic shell available in a selection of colors with complementary powder coat base or frame
 - Plastic glides with felt

Frame and Shell Finishes:

Off Black	
White	
Crayon Gray	
Pistachio	
Seattle Green	
Aubergine	
Red	
Haze Blue	

For larger swatches go to pg.188-205

Kin - KIN202U1
Arm chair with upholstered seat on 4 leg frame

Dimensions:

Seat Height	17.75"
Seat Width	19.25"
Seat Depth	18.75"
Overall Height	32.25"
Overall Width	23.5"
Overall Depth	22"

- Standard Features:
- Plastic shell finished in Off Black
 - Upholstered seat pad
 - Tubular steel frame finished in -Off Black powder coat
 - Plastic glides
 - Stacks up to 4 high

- Optional Features:
- Plastic shell available in a selection of colors with complementary powder coat base or frame
 - Plastic glides with felt

Frame and Shell Finishes:

Off Black	
White	
Crayon Gray	
Pistachio	
Seattle Green	
Aubergine	
Red	
Haze Blue	

For larger swatches go to pg.188-205



↓ Scan here to discover more



↓ Scan here to discover more



Kin

Design by Pearson Lloyd

40

41

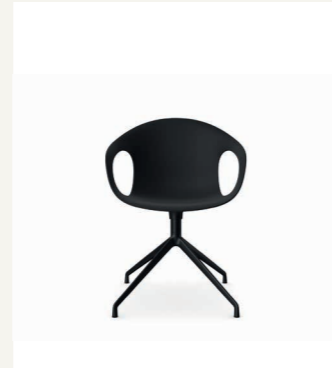
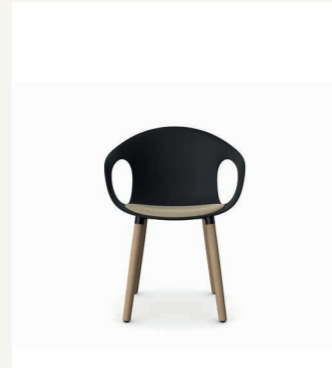

Kin - KIN203
Arm chair on wood legs

Dimensions:
 Seat Height 17.25"
 Seat Width 19.25"
 Seat Depth 18.75"
 Overall Height 32"
 Overall Width 23.5"
 Overall Depth 22"

Standard Features:
 — Plastic shell finished in Off Black
 — Aluminum leg connector frame finished in Off Black powder coat
 — Solid Ash legs with a clear finish
 — Plastic glides

Optional Features:
 — Plastic shell available in a selection of colors with complementary powder coat base or frame
 — Solid Ash legs can be stained or color matched to complement shell
 — Plastic glides with felt

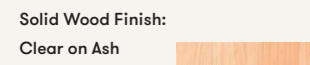

For larger swatches go to pg.188-205

6 optional Wood Stains and 8 color washes based on Ash are also available please go to pg.193 and 195 to see more.

Kin - KIN203U1
Arm chair with upholstered seat with wood legs

Dimensions:
 Seat Height 17.25"
 Seat Width 19.25"
 Seat Depth 18.75"
 Overall Height 32"
 Overall Width 23.5"
 Overall Depth 22"

Standard Features:
 — Plastic shell finished in Off Black
 — Upholstered seat pad
 — Aluminum leg connector frame finished in Off Black powder coat
 — Solid Ash legs with a clear finish
 — Plastic glides

Optional Features:
 — Plastic shell available in a selection of colors with complementary powder coat base or frame
 — Solid Ash legs can be stained or color matched to complement shell
 — Plastic glides with felt

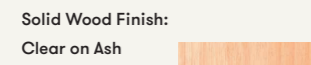

For larger swatches go to pg.188-205

6 optional Wood Stains and 8 color washes based on Ash are also available please go to pg.193 and 195 to see more.

Kin - KIN204
Arm chair on 4 star swivel base

Dimensions:
 Seat Height 17.25"
 Seat Width 19.25"
 Seat Depth 18.75"
 Overall Height 32"
 Overall Width 23.5"
 Overall Depth 22"

Standard Features:
 — Plastic shell finished in Off Black
 — 4 star swivel base on glides finished in Off Black powder coat
 — Plastic glides

Optional Features:
 — Plastic shell available in a selection of colors with complementary powder coat base or frame
 — 4 star auto return base on glides
 — 4 star fixed base on 2" hard wheel casters
 — Plastic glides with felt

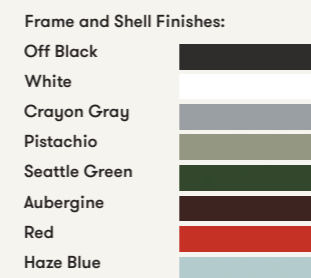

For larger swatches go to pg.188-205

Kin

Design by Pearson Lloyd

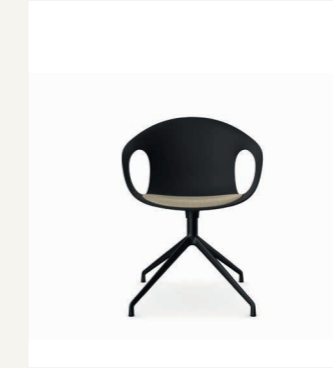

Kin - KIN204U1
Arm chair with upholstered seat on 4 star swivel base

Dimensions:
 Seat Height 17.25"
 Seat Width 19.25"
 Seat Depth 18.75"
 Overall Height 32"
 Overall Width 23.5"
 Overall Depth 22"

Standard Features:
 — Plastic shell finished in Off Black
 — Upholstered seat pad
 — 4 star swivel base on glides finished in Off Black powder coat
 — Plastic glides

Optional Features:
 — Plastic shell available in a selection of colors with complementary powder coat base or frame
 — 4 star auto return base on glides
 — 4 star fixed base on 2" hard wheel casters
 — Plastic glides with felt



For larger swatches go to pg.188-205

Kin - KIN205
Arm chair on 5 star swivel base

Dimensions:
 Seat Height 15.5"-20.5"
 Seat Width 19.25"
 Seat Depth 18.75"
 Overall Height 30"-34.5"
 Overall Width 24.5"
 Overall Depth 24"

Standard Features:
 — Plastic shell finished in Off Black
 — 5 star swivel base with height adjustment on casters finished in Off Black powder coat
 — 2" hard wheel casters

Optional Features:
 — Plastic shell available in a selection of colors with complementary powder coat base or frame
 — Soft wheel casters



For larger swatches go to pg.188-205

Kin - KIN205U1
Arm chair with upholstered seat on 5 star swivel base

Dimensions:
 Seat Height 15.5"-20.5"
 Seat Width 19.25"
 Seat Depth 18.75"
 Overall Height 30"-34.5"
 Overall Width 24.5"
 Overall Depth 24"

Standard Features:
 — Plastic shell finished in Off Black
 — Upholstered seat pad
 — 5 star swivel base with height adjustment on casters finished in Off Black powder coat
 — 2" hard wheel casters

Optional Features:
 — Plastic shell available in a selection of colors with complementary powder coat base or frame
 — Soft wheel casters



For larger swatches go to pg.188-205

↓ Scan here to discover more



↓ Scan here to discover more



Kin

Design by Pearson Lloyd

42

43

Kin

Design by Pearson Lloyd

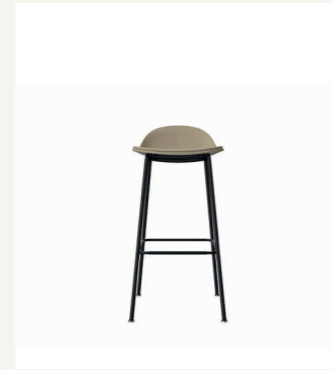
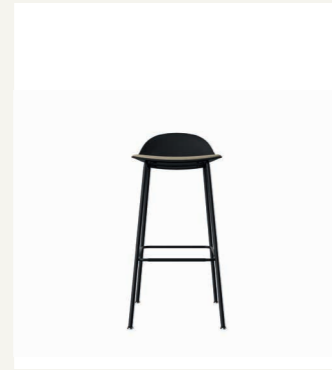
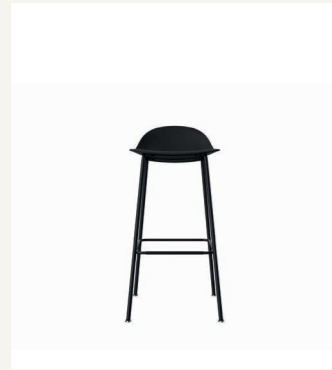

Kin - KIN502
Low back stool on 4 leg frame

Dimensions:
 Seat Height 29.25"
 Seat Width 16.25"
 Seat Depth 17.75"
 Overall Height 34.75"
 Overall Width 17.5"
 Overall Depth 18"

- Standard Features:**
- Plastic shell finished in Off Black
 - Tubular steel frame finished in Off Black powder coat
 - Footrest protector
 - Plastic glides

- Optional Features:**
- Plastic shell available in a selection of colors with complementary powder coat base or frame
 - Plastic glides with felt
 - Counter height stool option, seat height 24.5" (add CH to product code)



For larger swatches go to pg.188-205

Kin - KIN502U1
Low back stool with upholstered seat on 4 leg frame

Dimensions:
 Seat Height 29.25"
 Seat Width 16.25"
 Seat Depth 17.75"
 Overall Height 34.75"
 Overall Width 17.5"
 Overall Depth 18"

- Standard Features:**
- Plastic shell finished in Off Black
 - Upholstered seat pad
 - Tubular steel frame finished in Off Black powder coat
 - Footrest protector
 - Plastic glides

- Optional Features:**
- Plastic shell available in a selection of colors with complementary powder coat base or frame
 - Plastic glides with felt
 - Counter height stool option, seat height 24.5" (add CH to product code)



For larger swatches go to pg.188-205

Kin - KIN502U3
Fully upholstered low back stool on 4 leg frame

Dimensions:
 Seat Height 29.25"
 Seat Width 16.25"
 Seat Depth 17.75"
 Overall Height 34.75"
 Overall Width 17.5"
 Overall Depth 18"

- Standard Features:**
- Fully upholstered shell
 - Tubular steel frame finished in Off Black powder coat
 - Footrest protector
 - Plastic glides

- Optional Features:**
- Plastic glides with felt
 - Counter height stool option, seat height 24.5" (add CH to product code)
 - Two-tone upholstery



For larger swatches go to pg.188-205

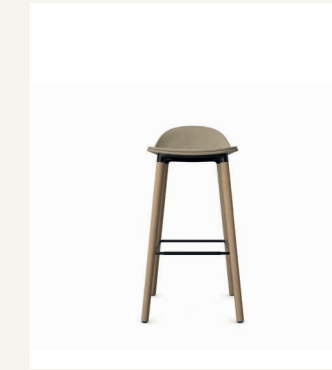
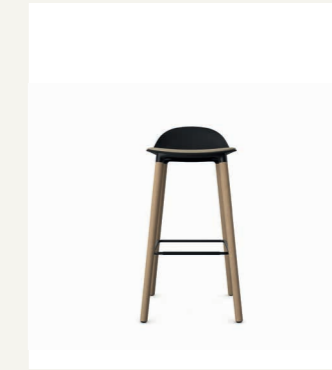
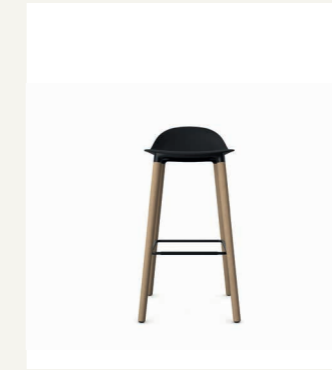

Kin - KIN503
Low back stool on wood legs

Dimensions:
 Seat Height 29.25"
 Seat Width 16.25"
 Seat Depth 17.75"
 Overall Height 34.75"
 Overall Width 17.5"
 Overall Depth 19"

- Standard Features:**
- Plastic shell finished in Off Black
 - Aluminum leg connector frame and footrest finished in Off Black powder coat
 - Solid Ash legs with a clear finish
 - Footrest protector
 - Plastic glides

- Optional Features:**
- Plastic shell available in a selection of colors with complementary powder coat base or frame
 - Solid Ash legs can be stained or color matched to complement shell
 - Plastic glides with felt

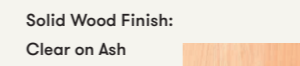
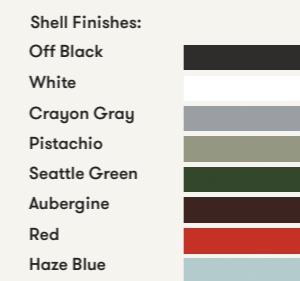

For larger swatches go to pg.188-205

6 optional Wood Stains and 8 color washes based on Ash are also available please go to pg.193 and 195 to see more.

Kin - KIN503U1
Low back stool with upholstered seat on wood legs

Dimensions:
 Seat Height 29.25"
 Seat Width 16.25"
 Seat Depth 17.75"
 Overall Height 34.75"
 Overall Width 17.5"
 Overall Depth 19"

- Standard Features:**
- Plastic shell finished in Off Black
 - Upholstered seat pad
 - Aluminum leg connector frame and footrest finished in Off Black powder coat
 - Solid Ash legs with a clear finish
 - Footrest protector
 - Plastic glides

- Optional Features:**
- Plastic shell available in a selection of colors with complementary powder coat base or frame
 - Solid Ash legs can be stained or color matched to complement shell
 - Plastic glides with felt

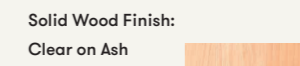
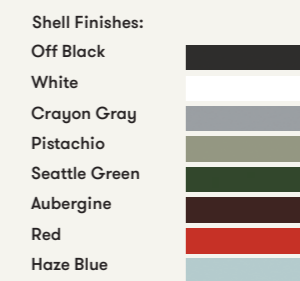

For larger swatches go to pg.188-205

6 optional Wood Stains and 8 color washes based on Ash are also available please go to pg.193 and 195 to see more.

Kin - KIN503U3
Fully upholstered low back stool on wood legs

Dimensions:
 Seat Height 29.25"
 Seat Width 16.25"
 Seat Depth 17.75"
 Overall Height 34.75"
 Overall Width 17.5"
 Overall Depth 19"

- Standard Features:**
- Fully upholstered shell
 - Aluminum leg connector frame and footrest finished in Off Black powder coat
 - Solid Ash legs with a clear finish
 - Footrest protector
 - Plastic glides

- Optional Features:**
- Solid Ash legs can be stained or color matched to complement shell
 - Plastic glides with felt
 - Two-tone upholstery

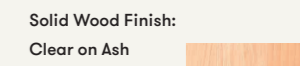
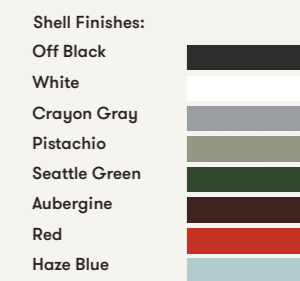

For larger swatches go to pg.188-205

6 optional Wood Stains and 8 color washes based on Ash are also available please go to pg.193 and 195 to see more.

↓ Scan here to discover more



↓ Scan here to discover more



Kin

Design by Pearson Lloyd

44

45

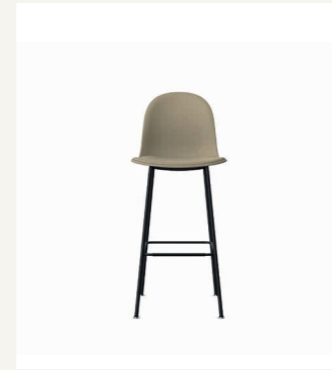
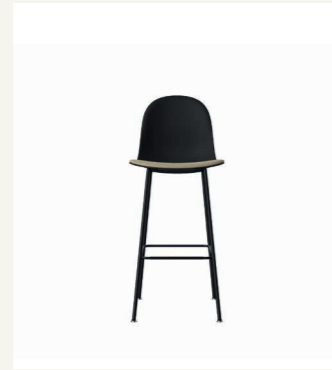
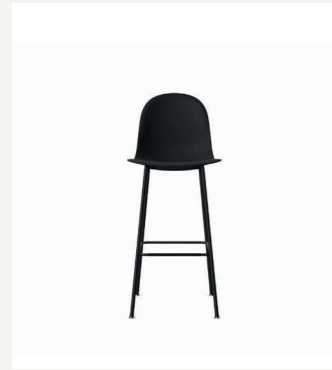

Kin - KIN602
High back stool on 4 leg frame

Dimensions:
 Seat Height 29.25"
 Seat Width 18"
 Seat Depth 21"
 Overall Height 44"
 Overall Width 18"
 Overall Depth 21"

- Standard Features:
- Plastic shell finished in Off Black
 - Tubular steel frame finished in Off Black powder coat
 - Footrest protector
 - Plastic glides

- Optional Features:
- Plastic shell available in a selection of colors with complementary powder coat base or frame
 - Plastic glides with felt
 - Counter height stool option, seat height 24.5" (add CH to product code)



For larger swatches go to pg.188-205

Kin - KIN602U1
High back stool with upholstered seat on 4 leg frame

Dimensions:
 Seat Height 29.25"
 Seat Width 18"
 Seat Depth 21"
 Overall Height 44"
 Overall Width 18"
 Overall Depth 21"

- Standard Features:
- Plastic shell finished in Off Black
 - Upholstered seat pad
 - Tubular steel frame finished in Off Black powder coat
 - Footrest protector
 - Plastic glides

- Optional Features:
- Plastic shell available in a selection of colors with complementary powder coat base or frame
 - Plastic glides with felt
 - Counter height stool option, seat height 24.5" (add CH to product code)



For larger swatches go to pg.188-205

Kin - KIN602U3
Fully upholstered high back stool with 4 leg frame

Dimensions:
 Seat Height 29.25"
 Seat Width 18"
 Seat Depth 21"
 Overall Height 44"
 Overall Width 18"
 Overall Depth 21"

- Standard Features:
- Fully upholstered shell
 - Tubular steel frame finished in Off Black powder coat
 - Footrest protector
 - Plastic glides

- Optional Features:
- Plastic shell available in a selection of colors with complementary powder coat base or frame
 - Plastic glides with felt
 - Counter height stool option, seat height 24.5" (add CH to product code)
 - Two-tone upholstery



For larger swatches go to pg.188-205



↓ Scan here to discover more



↓ Scan here to discover more



Mollie

Design by John Coleman

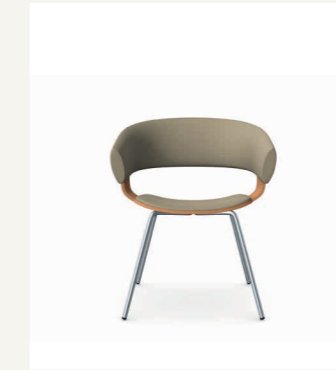

Mollie - A680
Chair on a 4 leg frame

Dimensions:
 Seat Height 18"
 Seat Width 17"
 Seat Depth 17.5"
 Overall Height 29.25"
 Overall Width 23.5"
 Overall Depth 22"

- Standard Features and Finishes:
- Tubular Steel frame in Silver M04 powdercoat
 - Beech shell in a clear finish
 - Upholstered seat and back
 - Plastic glides

- Optional Features:
- Tubular Steel frame available in Polished Chrome
 - Beech Shell can be stained or color washed
 - Oak / Walnut veneer shell with a clear finish
 - Plastic glides with felt
 - Two-tone upholstery

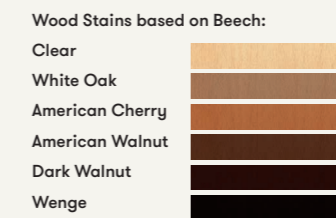
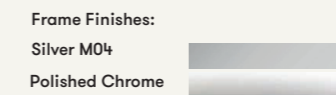

For larger swatches go to pg.188-205

16 optional standard color washes based on Beech are also available please go to pg. 194 to see more.



Mollie - A685
Chair on a 4 leg wood

Dimensions:
 Seat Height 17.75"
 Seat Width 17"
 Seat Depth 17.5"
 Overall Height 29.75"
 Overall Width 23.5"
 Overall Depth 22"

- Standard Features and Finishes:
- Beech shell and conical legs in a clear finish
 - Aluminum leg connector frame finished in Gray powder coat
 - Upholstered seat and back
 - Plastic glides

- Optional Features:
- Beech Shell and Legs can be stained or color washed
 - Oak / Walnut veneer shell with a clear finish
 - Solid Oak legs with a clear finish
 - Aluminum leg connector frame finished in Black powder coat
 - Two-tone upholstery

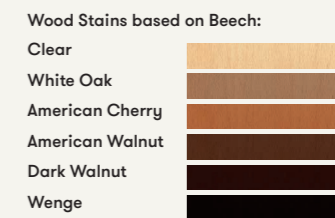
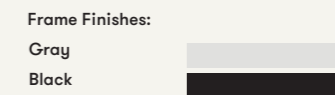

For larger swatches go to pg.188-205

16 optional standard color washes based on Beech are also available please go to pg. 194 to see more.



Mollie

Design by John Coleman

46

47

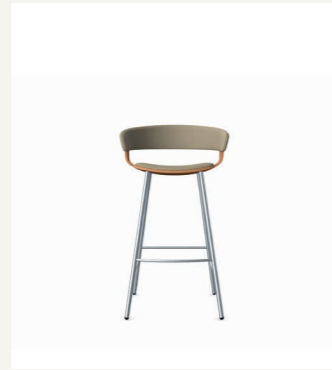
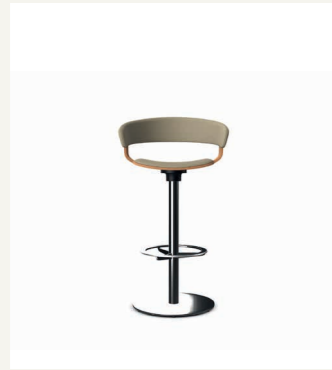

Mollie - A582
Stool on swivel pedestal base

Dimensions:
 Seat Height 29.5"
 Seat Width 15.75"
 Seat Depth 17.25"
 Overall Height 39.25"
 Overall Width 22"
 Overall Depth 20"

Standard Features:
 — Beech shell in a clear finish
 — Steel swivel pedestal base and footring finished in Polished Chrome
 — Upholstered seat and back
 — Plastic glides

Optional Features:
 — Beech shell can be stained or color washed
 — Two-tone upholstery
 — Counter height stool option, seat height 24.5" (add CH to product code)

Frame Finish:
 Polished Chrome

Wood Stains based on Beech:
 Clear
 White Oak
 American Cherry
 American Walnut
 Dark Walnut
 Wenge

For larger swatches go to pg.188-205

16 optional standard color washes based on Beech are also available please go to pg. 194 to see more.



Mollie - A583
Stool on 4 leg frame

Dimensions:
 Seat Height 29.5"
 Seat Width 15.75"
 Seat Depth 17.25"
 Overall Height 39.25"
 Overall Width 22"
 Overall Depth 20"

Standard Features:
 — Beech shell with a clear finish
 — Tubular steel frame finished in Silver M04 powder coat
 — Upholstered seat and back
 — Plastic glides

Optional Features:
 — Tubular steel frame available in Polished Chrome
 — Beech shell can be stained or color washed
 — Plastic glides with felt
 — Two-tone upholstery
 — Counter height stool option, seat height 24.5" (add CH to product code)

Frame Finishes:
 Silver M04
 Polished Chrome

Wood Stains based on Beech:
 Clear
 White Oak
 American Cherry
 American Walnut
 Dark Walnut
 Wenge

For larger swatches go to pg.188-205

16 optional standard color washes based on Beech are also available please go to pg. 194 to see more.

Ooty

Design by SmithMatthias

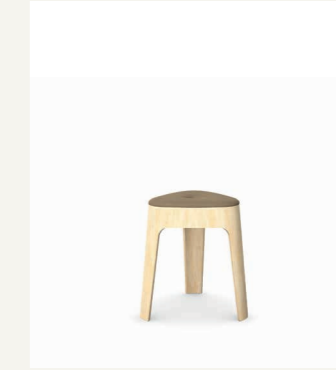
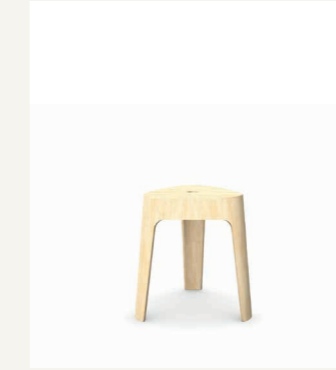

Ooty - OTY01
Stool

Dimensions:
 Seat Height 17.5"
 Seat Width 13"
 Seat Depth 13"
 Overall Height 17.5"
 Overall Width 17"
 Overall Depth 17"

Standard Features:
 — Ash veneered plywood frame with a clear finish
 — Stacks up to 6 high

Optional Features:
 — Ash veneered plywood frame can be color washed

Veneer:
 Plywood Clear

Color Washes based on Ash:
 Back to Black
 White as Snow
 Peacock Blue
 Coral
 Haze Blue

For larger swatches go to pg.188-205



Ooty - OTYU1
Stool with cushion

Dimensions:
 Seat Height 18.5"
 Seat Width 13"
 Seat Depth 13"
 Overall Height 18.5"
 Overall Width 17"
 Overall Depth 17"

Standard Features:
 — Ash veneer plywood frame
 — Upholstered seat pad in Kvadrat Melange Nap
 — Stacks up to 6 high

Optional Features:
 — Ash veneered plywood frame can be color washed

Veneer:
 Plywood Clear

Color Washes based on Ash:
 Back to Black
 White as Snow
 Peacock Blue
 Coral
 Haze Blue

Seat Pad:
 Melange Nap 951
 Melange Nap 521
 Melange Nap 711
 Melange Nap 111
 Melange Nap 271
 Melange Nap 211
 Melange Nap 191

For larger swatches go to pg.188-205

↓ Scan here to discover more



↓ Scan here to discover more



↓ Scan here to discover more

↓ Scan here to discover more

Phoulds – Wood Shell

Design by Allermuir Design Studio

48

49

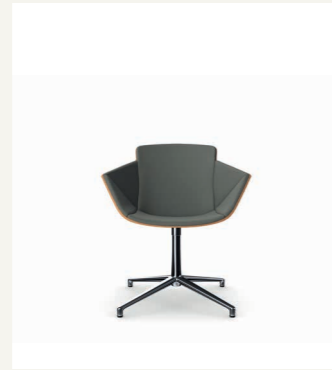
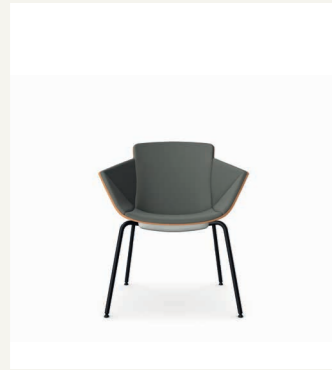

Phoulds - PH1 Medium back chair with wood shell on 4 leg frame

Dimensions:

Seat Height	17.75"
Seat Width	15.25"
Seat Depth	17.25"
Overall Height	30.5"
Overall Width	26.75"
Overall Depth	23.5"

Standard Features:

- 6 panel upholstery with CMHR foam
- Beech shell with a clear finish
- Plastic under seat shroud
- Tubular Steel frame finished in Polished Chrome with self-leveling glides

Optional Features:

- Tubular Steel frame available in Black powder coat
- Beech shell can be stained or color washed
- Walnut veneer shell with a clear finish
- Plastic self-leveling glides with felt
- Two-tone upholstery

Frame Finishes:



Veneer:

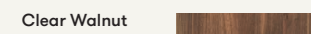

Wood Stains based on Beech:



For larger swatches go to pg.188-205

16 optional standard color washes based on Beech are also available please go to pg. 194 to see more.



Phoulds - PH2 Medium back chair with wood shell on 4 star base

Dimensions:

Seat Height	17.75"
Seat Width	15.25"
Seat Depth	17.25"
Overall Height	30.5"
Overall Width	28.5"
Overall Depth	28.5"

Standard Features:

- 6 panel upholstery with CMHR foam
- Beech shell with a clear finish
- 4-star Polished Aluminum base with plastic glides

Optional Features:

- Beech shell can be stained or color washed
- Walnut veneer shell with a clear finish
- Two-tone upholstery

Frame Finish:

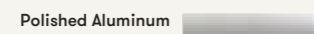

Veneer:

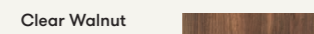

Wood Stains based on Beech:



For larger swatches go to pg.188-205

16 optional standard color washes based on Beech are also available please go to pg. 194 to see more.



Phoulds - PH7 Medium back chair with wood shell on 5 star base and casters

Dimensions:

Seat Height	16.75"-21.5"
Seat Width	15.25"
Seat Depth	17.25"
Overall Height	30.5"
Overall Width	26.75"
Overall Depth	26.75"

Standard Features:

- 6 panel upholstery with CMHR foam
- Beech shell with a clear finish
- 5-star Polished Aluminum base with casters
- Seat height adjustment

Optional Features:

- Beech shell can be stained or color washed
- Walnut veneer shell with a clear finish
- Two-tone upholstery

Frame Finish:

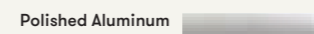

Veneer:

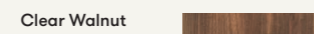

Wood Stains based on Beech:



For larger swatches go to pg.188-205

16 optional standard color washes based on Beech are also available please go to pg. 194 to see more.



↓ Scan here to discover more



Phoulds – Wood Shell

Design by Allermuir Design Studio

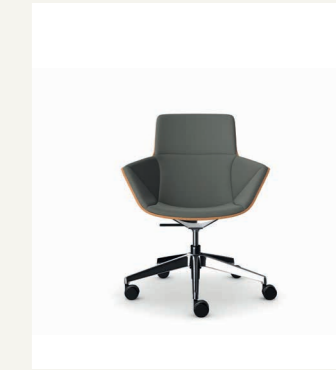
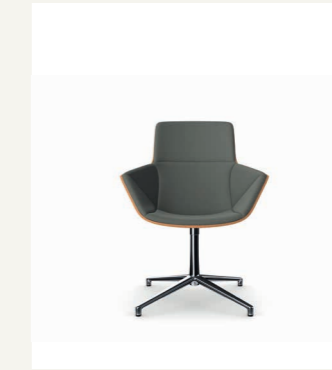
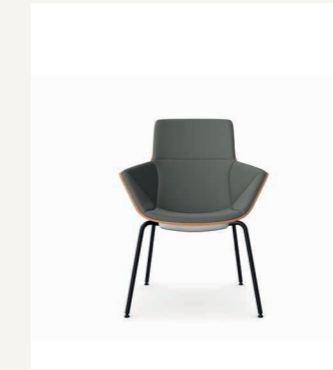

Phoulds - PH3 High back chair with wood shell on 4 leg frame

Dimensions:

Seat Height	17.75"
Seat Width	15.25"
Seat Depth	17.25"
Overall Height	35.25"
Overall Width	28.5"
Overall Depth	25.25"

Standard Features:

- 6 panel upholstery with CMHR foam
- Beech shell with a clear finish
- Plastic under seat shroud
- Tubular Steel frame finished in Polished Chrome with self-leveling glides

Optional Features:

- Tubular Steel frame available in Black powder coat
- Beech shell can be stained or color washed
- Walnut veneer shell with a clear finish
- Plastic self leveling glides with felt
- Two-tone upholstery

Frame Finishes:



Veneer:

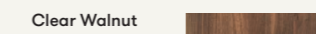

Wood Stains based on Beech:



For larger swatches go to pg.188-205

16 optional standard color washes based on Beech are also available please go to pg. 194 to see more.



Phoulds - PH4 High back chair with wood shell on 4 star base

Dimensions:

Seat Height	17.75"
Seat Width	15.25"
Seat Depth	17.25"
Overall Height	35.25"
Overall Width	28.5"
Overall Depth	25.5"

Standard Features:

- 6 panel upholstery with CMHR foam
- Beech shell with a clear finish
- Plastic under seat shroud
- 4-star Polished Aluminum base with felt glides

Optional Features:

- Beech shell can be stained or color washed
- Walnut veneer shell with a clear finish
- Two-tone upholstery

Frame Finish:

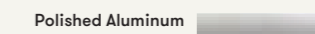

Veneer:

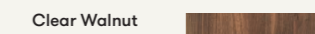

Wood Stains based on Beech:



For larger swatches go to pg.188-205

16 optional standard color washes based on Beech are also available please go to pg. 194 to see more.



Phoulds - PH8 High back chair with wood shell on 5 star base and casters

Dimensions:

Seat Height	16.75"-21.5"
Seat Width	15.25"
Seat Depth	17.25"
Overall Height	34.25"-39"
Overall Width	26.75"
Overall Depth	27.75"

Standard Features:

- 6 panel upholstery with CMHR foam
- Beech shell with a clear finish
- 5-star Polished Aluminum base with casters
- Seat height adjustment

Optional Features:

- Beech shell can be stained or color washed
- Walnut veneer shell with a clear finish
- Two-tone upholstery

Frame Finish:

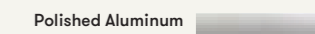

Veneer:

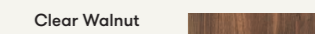

Wood Stains based on Beech:



For larger swatches go to pg.188-205

16 optional standard color washes based on Beech are also available please go to pg. 194 to see more.



↓ Scan here to discover more



Phoulds – Upholstered

Design by Allermuir Design Studio

50

51

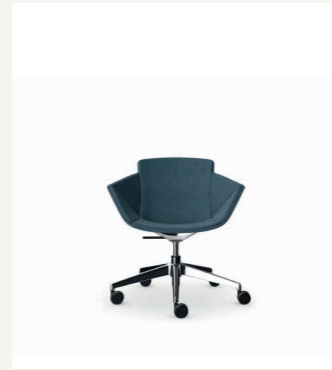
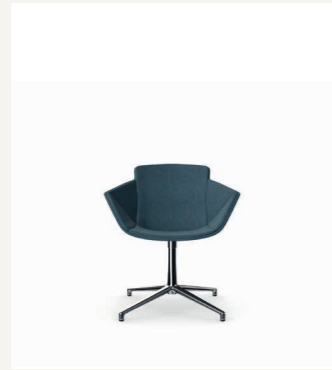
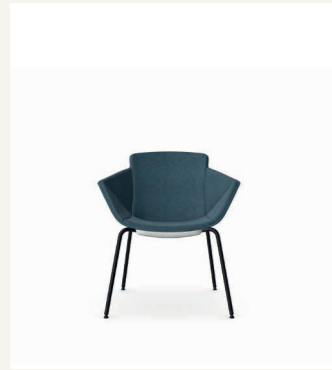

Phoulds - PH1U
Medium back 4 leg chair with upholstered shell

Dimensions:

Seat Height	17.75"
Seat Width	15.25"
Seat Depth	17.25"
Overall Height	30.5"
Overall Width	26.75"
Overall Depth	23.5"

Standard Features:

- 6 Panel upholstery with CMHR foam
- Fully upholstered outer shell
- Plastic under seat shroud
- Tubular steel frame finished in polished chrome with self-leveling glides

Optional Features:

- Tubular Steel frame available in Black powder coat
- Plastic self-leveling glides with felt
- Two-tone upholstery

Frame Finishes:



For larger swatches go to pg.188-205

Phoulds - PH2U
Medium back 4 star base chair with upholstered shell

Dimensions:

Seat Height	17.75"
Seat Width	15.25"
Seat Depth	17.25"
Overall Height	30.5"
Overall Width	28.5"
Overall Depth	28.5"

Standard Features:

- 6 panel upholstery with CMHR foam
- Fully upholstered outer shell
- 4-Star polished Aluminum base with felt glides

Optional Features:

- Two-tone upholstery

Base Finish:

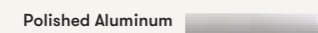

For larger swatches go to pg.188-205

Phoulds - PH7U
Medium back 5 star base chair on casters with upholstered shell

Dimensions:

Seat Height	16.75"-21.5"
Seat Width	15.25"
Seat Depth	17.25"
Overall Height	30.5"
Overall Width	26.75"
Overall Depth	26.75"

Standard Features:

- 6 panel upholstery with CMHR foam
- Fully upholstered outer shell
- 5-star Polished Aluminum base with casters
- Seat height adjustment

Optional Features:

- Two-tone upholstery

Base Finish:

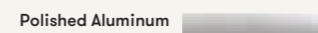

For larger swatches go to pg.188-205



↓ Scan here to discover more



↓ Scan here to discover more



Phoulds – Upholstered

Design by Allermuir Design Studio

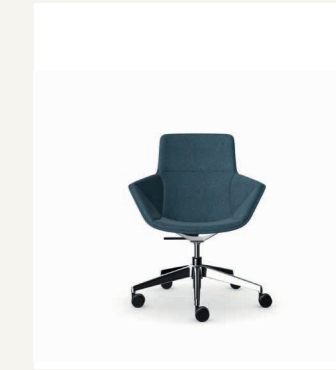
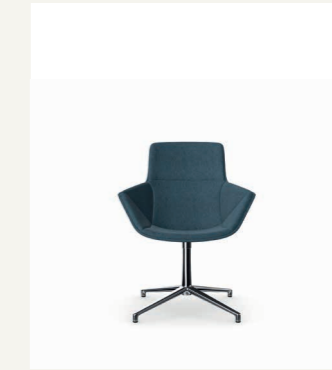
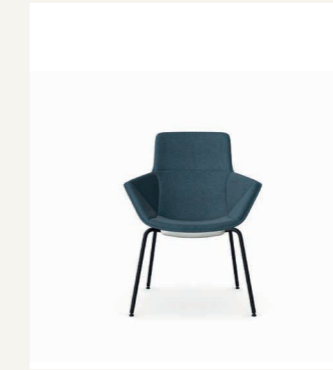

Phoulds - PH3U
High back 4 leg chair with upholstered shell frame

Dimensions:

Seat Height	17.75"
Seat Width	15.25"
Seat Depth	17.25"
Overall Height	35.25"
Overall Width	28.5"
Overall Depth	25.25"

Standard Features:

- 6 panel upholstery with CMHR foam
- Fully upholstered outer shell
- Plastic under seat shroud
- Tubular Steel frame finished in Polished Chrome with self-leveling glides

Optional Features:

- Tubular Steel frame available in Black powder coat
- Plastic self-leveling glides with felt
- Two-tone upholstery

Frame Finishes:

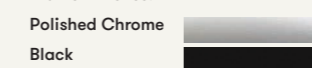

For larger swatches go to pg.188-205

Phoulds - PH4U
High back 4 star base chair with upholstered shell

Dimensions:

Seat Height	17.75"
Seat Width	15.25"
Seat Depth	17.25"
Overall Height	35.25"
Overall Width	28.5"
Overall Depth	25.5"

Standard Features:

- 6 panel upholstery with CMHR foam
- Fully upholstered outer shell
- 4 star polished Aluminum base with felt guides

Optional Features:

- Two-tone upholstery

Frame Finish:

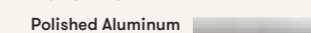

For larger swatches go to pg.188-205

Phoulds - PH8U
High back chair with upholstered shell on a 5 star base with casters

Dimensions:

Seat Height	16.75"-21.5"
Seat Width	15.25"
Seat Depth	17.25"
Overall Height	34.25"-39"
Overall Width	26.75"
Overall Depth	27.75"

Standard Features:

- 6 panel upholstery with CMHR foam
- Fully upholstered outer shell
- 5-star Polished Aluminum base with casters
- Seat height adjustment

Optional Features:

- Two-tone upholstery

Frame Finish

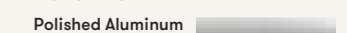

For larger swatches go to pg.188-205



Phoulds – Quilted

Design by Allermuir Design Studio

52

53

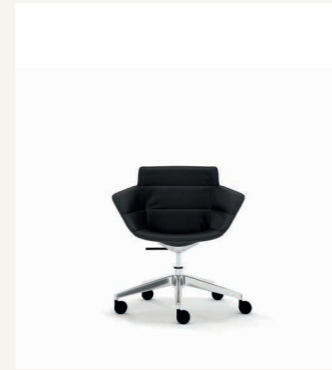
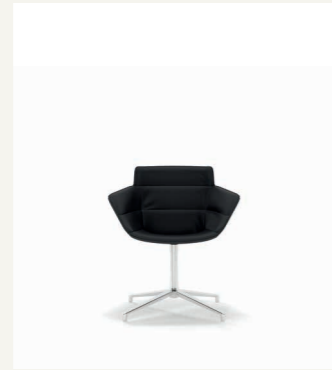
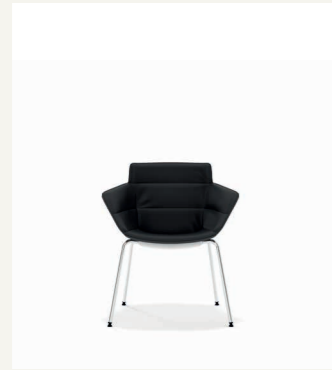

Phoulds - PH11U
Medium back 4 leg chair with soft quilted upholstery

Dimensions:

Seat Height	17.75"
Seat Width	15.25"
Seat Depth	17.25"
Overall Height	30.5"
Overall Width	26.75"
Overall Depth	23.5"

Standard Features:

- Soft quilted upholstery
- Fully upholstered outer shell
- Plastic under seat shroud
- Tubular steel frame finished in Polished Chrome with self-leveling glides

Optional Features:

- Tubular Steel frame available in Black powder coat
- Plastic self-leveling glides with felt
- Two-tone upholstery

Frame Finishes:

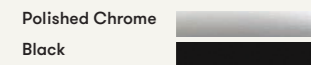

For larger swatches go to pg.188-205

Phoulds - PH12U
Medium back 4- Star base chair with soft quilted upholstery

Dimensions:

Seat Height	17.75"
Seat Width	15.25"
Seat Depth	17.25"
Overall Height	30.5"
Overall Width	28.5"
Overall Depth	28.5"

Standard Features:

- Soft quilted upholstery
- Fully upholstered outer shell
- 4-Star Polished Aluminum base with felt glides

Optional Features:

- Two-tone upholstery

Frame Finish:

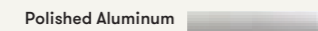

For larger swatches go to pg.188-205

Phoulds - PH17U
Medium back 5- Star base chair on casters with soft quilted upholstery

Dimensions:

Seat Height	16.75"-21.5"
Seat Width	15.25"
Seat Depth	17.25"
Overall Height	30.5"
Overall Width	26.75"
Overall Depth	26.75"

Standard Features:

- Soft quilted upholstery
- Fully upholstered outer shell
- 5-star Polished Aluminum base with casters
- Seat height adjustment

Optional Features:

- Two-tone upholstery

Frame Finish:

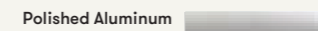

For larger swatches go to pg.188-205



↓ Scan here to discover more



↓ Scan here to discover more



Phoulds – Quilted

Design by Allermuir Design Studio

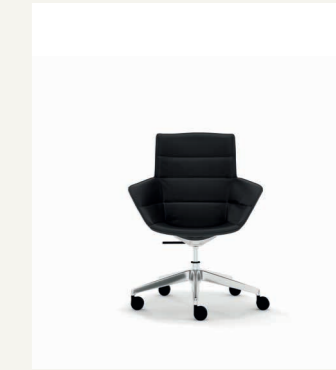
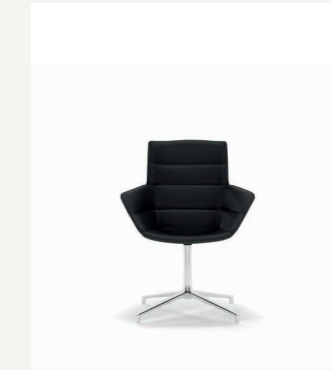
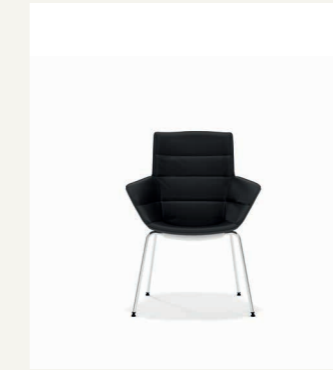

Phoulds - PH13U
High back 4 leg chair with soft quilted upholstery

Dimensions:

Seat Height	17.75"
Seat Width	15.25"
Seat Depth	17.25"
Overall Height	35.25"
Overall Width	28.5"
Overall Depth	25.25"

Standard Features:

- Soft quilted upholstery
- Fully upholstered outer shell
- Plastic under seat shroud
- Tubular Steel frame finished in Polished Chrome with self-leveling glides

Optional Features:

- Tubular Steel frame available in Black powder coat
- Plastic self-leveling glides with felt
- Two-tone upholstery

Frame Finishes:

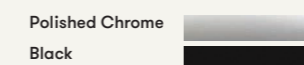

For larger swatches go to pg.188-205

Phoulds - PH14U
High back 4- Star base chair with soft quilted upholstery

Dimensions:

Seat Height	17.75"
Seat Width	15.25"
Seat Depth	17.25"
Overall Height	35.25"
Overall Width	28.5"
Overall Depth	25.5"

Standard Features:

- Soft quilted upholstery
- Fully upholstered outer shell
- Plastic under seat shroud
- 4-Star polished Aluminum base with felt guides

Optional Features:

- Two-tone upholstery

Frame Finish:

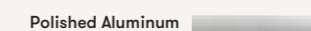

For larger swatches go to pg.188-205

Phoulds - PH18U
High back 5- Star base chair on casters with soft quilted upholstery

Dimensions:

Seat Height	16.75"-21.5"
Seat Width	15.25"
Seat Depth	17.25"
Overall Height	34.25"-39"
Overall Width	26.75"
Overall Depth	27.75"

Standard Features:

- Soft quilted upholstery
- Fully upholstered outer shell
- 5-star Polished Aluminum base with casters
- Seat height adjustment

Optional Features:

- Two-tone upholstery

Frame Finish:

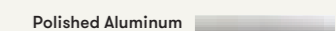

For larger swatches go to pg.188-205



Scoop

Design By Mark Gabbertas

54

55

Tommo

Design By Mark Gabbertas

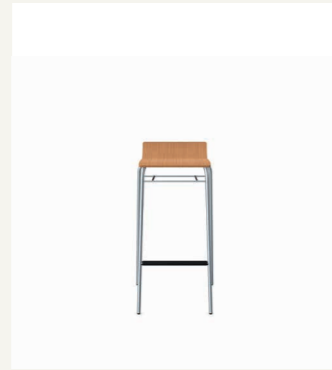
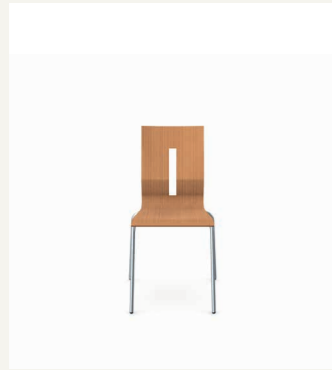

Scoop - A432
High stool low back

Dimensions:
 Seat Height 18"
 Seat Width 15.75"
 Seat Depth 16.5"
 Overall Height 35"
 Overall Width 20"
 Overall Depth 21.25"

- Standard Features:
- Tubular steel frame finished in Silver M04
 - Plastic glides
 - Alpi Walnut veneer shell with a clear finish
 - Stacks 8 high

- Optional Features:
- Plastic glides with felt
 - Tubular Steel frame available in Polished Chrome

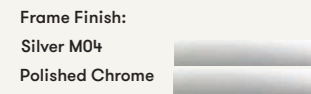

For larger swatches go to pg.188-205

Scoop - A430
High stool low back

Dimensions:
 Seat Height 29.75"
 Seat Width 13.5"
 Seat Depth 15"
 Overall Height 32.25"
 Overall Width 17.25"
 Overall Depth 17.75"

- Standard Features:
- Tubular steel frame finished in Silver M04
 - Plastic glides
 - Alpi Walnut veneer shell with a clear finish
 - Stacks 4 high

- Optional Features:
- Plastic glides with felt
 - Tubular Steel frame available in Polished Chrome
 - Counter height stool option, seat height 24.5" (add CH to product code)

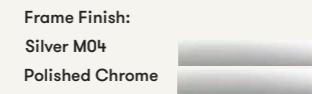

For larger swatches go to pg.188-205

Scoop - A433
High stool high back

Dimensions:
 Seat Height 29"
 Seat Width 15.75"
 Seat Depth 16.5"
 Overall Height 42"
 Overall Width 16"
 Overall Depth 21"

- Standard Features:
- Tubular steel frame finished in Silver M04
 - Plastic glides
 - Alpi Walnut veneer shell with a clear finish
 - Stacks 4 high

- Optional Features:
- Plastic glides with felt
 - Tubular Steel frame available in Polished Chrome
 - Counter height stool option, seat height 24.5" (add CH to product code)

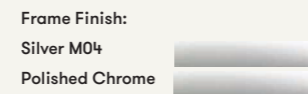

For larger swatches go to pg.188-205



↓ Scan here to discover more



↓ Scan here to discover more

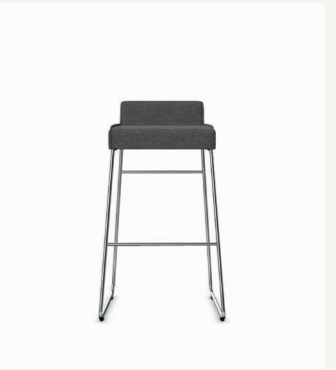
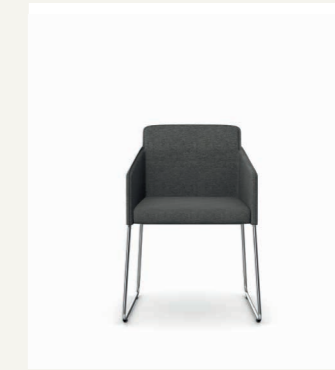
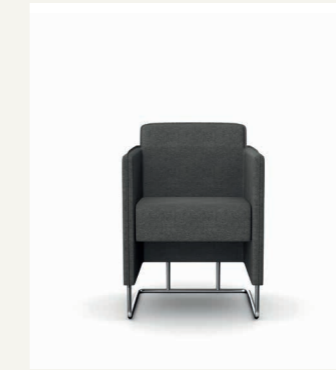

Tommo - A530
Club chair

Dimensions:
 Seat Height 19"
 Seat Width 19.25"
 Seat Depth 18"
 Overall Height 31.5"
 Overall Width 22"
 Overall Depth 22.5"

- Standard Features:
- Traditional carcass construction
 - Fully upholstered
 - Tubular Steel frame finished in Polished Chrome
 - Plastic glides

- Optional Features:
- Two-tone upholstery

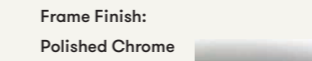

For larger swatches go to pg.188-205

Tommo - A532
Dining chair

Dimensions:
 Seat Height 19"
 Seat Width 18.5"
 Seat Depth 17.5"
 Overall Height 31"
 Overall Width 22"
 Overall Depth 21.75"

- Standard Features:
- Traditional carcass construction
 - Fully upholstered
 - Tubular Steel frame finished in Polished Chrom
 - Plastic glides

- Optional Features:
- Two-tone upholstery

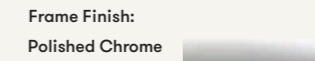

For larger swatches go to pg.188-205

Tommo - A534
High stool

Dimensions:
 Seat Height 29.5"
 Seat Width 16.25"
 Seat Depth 15.75"
 Overall Height 32.75"
 Overall Width 19"
 Overall Depth 19"

- Standard Features:
- Traditional carcass construction
 - Fully upholstered
 - Tubular Steel frame finished in Polished Chrom
 - Plastic glides

- Optional Features:
- Two-tone upholstery
 - Counter height stool option, seat height 24.5" (add CH to product code)

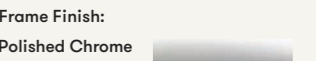

For larger swatches go to pg.188-205

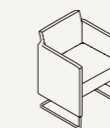

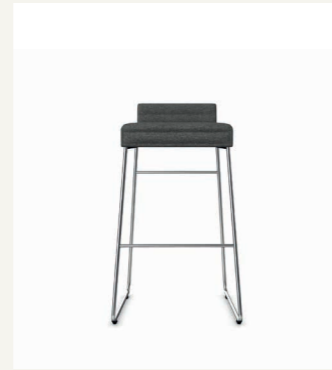
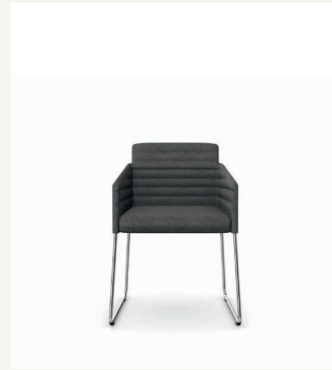
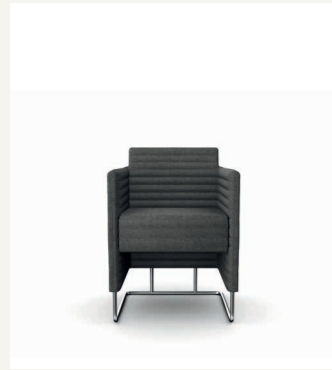

Tommo - A530Q
Club chair

Dimensions:

Seat Height	19"
Seat Width	19.25"
Seat Depth	18"
Overall Height	31.5"
Overall Width	22"
Overall Depth	22.5"

Standard Features:

- Traditional carcass construction
- Fully upholstered
- Soft Quilted Upholstery
- Tubular Steel frame finished in Polished Chrome
- Plastic glides

Optional Features:

- Two-tone upholstery

Frame Finish:

Polished Chrome 

For larger swatches go to pg.188-205

Tommo - A532Q
Dining chair

Dimensions:

Seat Height	19"
Seat Width	18.5"
Seat Depth	17.5"
Overall Height	31"
Overall Width	22"
Overall Depth	21.75"

Standard Features:

- Traditional carcass construction
- Fully upholstered
- Soft Quilted Upholstery
- Tubular Steel frame finished in Polished Chrome
- Plastic glides

Optional Features:

- Plastic guides available with felt
- Two-tone upholstery

Frame Finish:

Polished Chrome 

For larger swatches go to pg.188-205

Tommo - A534Q
High stool

Dimensions:

Seat Height	29.5"
Seat Width	16.25"
Seat Depth	15.75"
Overall Height	32.75"
Overall Width	19"
Overall Depth	19"

Standard Features:

- Traditional carcass construction
- Fully upholstered
- Soft Quilted Upholstery
- Tubular Steel frame finished in Polished Chrome
- Plastic glides

Optional Features:

- Plastic guides available with felt
- Counter height stool option, seat height 625mm (add CH to product code)

Frame Finish:

Polished Chrome 

For larger swatches go to pg.188-205

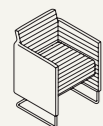

↓ Scan here to discover more



↓ Scan here to discover more

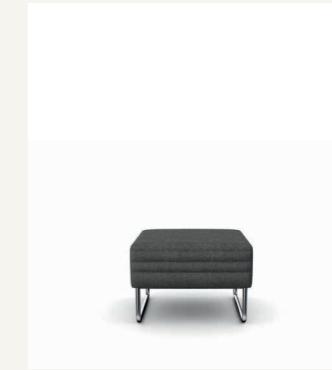
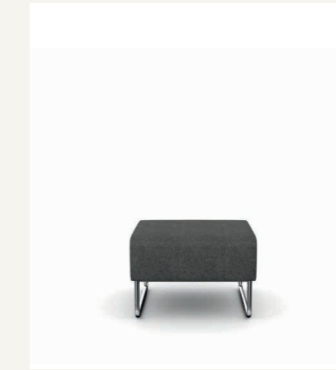

Tommo - A531
Footstool

Dimensions:

Overall Height	12.5"
Overall Width	18.5"
Overall Depth	18.5"

Standard Features:

- Traditional carcass construction
- Fully upholstered
- Tubular Steel frame finished in Polished Chrome

Optional Features:

- Two-tone upholstery

Frame Finish:

Polished Chrome 

For larger swatches go to pg.188-205

Tommo - A531Q
Footstool

Dimensions:

Overall Height	12.5"
Overall Width	18.5"
Overall Depth	18.5"

Standard Features:

- Traditional carcass construction
- Fully upholstered
- Soft Quilted Upholstery
- Tubular Steel frame finished in Polished Chrome

Optional Features:

- Two-tone upholstery

Frame Finish:

Polished Chrome 

For larger swatches go to pg.188-205

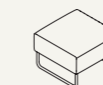

Contents

060	Conic
062	Famiglia
067	Fifty Series
070	Grainger
072	Haven
074	Haven Bench
076	Jinx
077	Lola
079	Mayze Mobile
080	Mozaik
082	Open
084	Pause
087	Pebble
088	Plum
092	Qu
093	Tarry
094	Tylus & Cushions
096	Venus

Conic

Design by Pearson Lloyd

60

61

Conic

Design By Pearson Lloyd

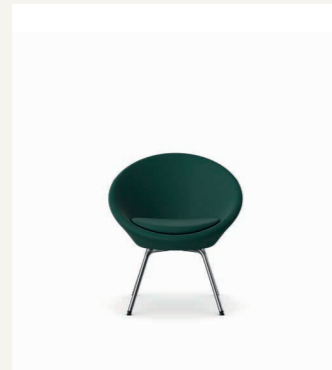
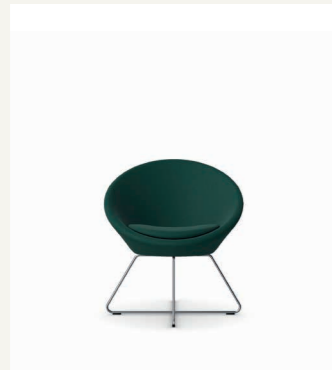

Conic - A630
Tub chair on a wire frame

Dimensions:
 Seat Height 19.25"
 Seat Width 18.5"
 Seat Depth 19"
 Overall Height 32"
 Overall Width 30.75"
 Overall Depth 26"

- Standard Features:
- Molded foam construction
 - Fully upholstered
 - Wire frame finished in Polished Chrome
 - Plastic glides

- Optional Features:
- Wire frame available in a selection of powder coat finishes
 - Two-tone upholstery
 - Decorative Railroad Stitch Detail in Black, White, Red, Light Gray, Dark Gray or Cream

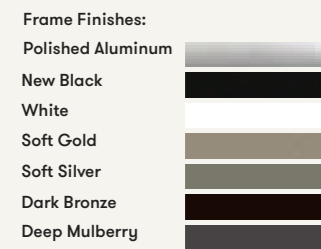

For larger swatches go to pg.188-205

Conic - A637
Tub chair on 4 leg frame

Dimensions:
 Seat Height 19.25"
 Seat Width 18.5"
 Seat Depth 19"
 Overall Height 32"
 Overall Width 30.75"
 Overall Depth 26"

- Standard Features:
- Molded foam construction
 - Fully upholstered
 - Tubular Steel frame finished in Polished Aluminum
 - Plastic self-leveling glides

- Optional Features:
- Tubular Steel frame available in a selection of powder coat finishes
 - Plastic self-leveling glides with felt
 - Two-tone upholstery
 - Decorative Railroad Stitch Detail in Black, White, Red, Light Gray, Dark Gray or Cream

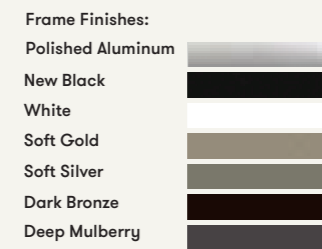

For larger swatches go to pg.188-205

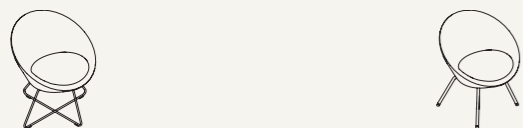

↓ Scan here to discover more



↓ Scan here to discover more

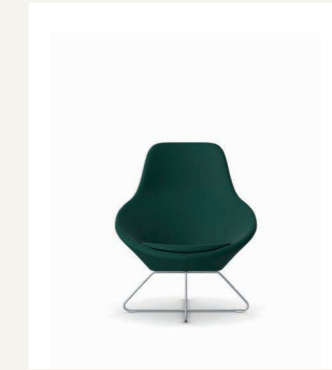

Conic - A631
Lounge chair on a wire frame

Dimensions:
 Seat Height 19"
 Seat Width 21.25"
 Seat Depth 20.5"
 Overall Height 29.5"
 Overall Width 35.5"
 Overall Depth 31.25"

- Standard Features:
- Molded foam construction
 - Fully upholstered
 - Wire frame finished in Polished Chrome
 - Plastic glides

- Optional Features:
- Wire frame available in a selection of powder coat finishes
 - Two-tone upholstery
 - Decorative Railroad Stitch Detail in Black, White, Red, Light Gray, Dark Gray or Cream

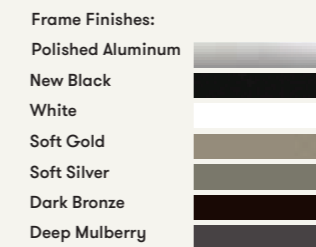

For larger swatches go to pg.188-205

Conic - A632
Lounge chair with integral headrest

Dimensions:
 Seat Height 18.5"
 Seat Width 21.25"
 Seat Depth 20.5"
 Overall Height 42"
 Overall Width 35.5"
 Overall Depth 32"

- Standard Features:
- Molded foam construction
 - Fully upholstered
 - Wire frame finished in Polished Chrome
 - Plastic glides

- Optional Features:
- Wire frame available in a selection of powder coat finishes
 - Two-tone upholstery
 - Decorative Railroad Stitch Detail in Black, White, Red, Light Gray, Dark Gray or Cream

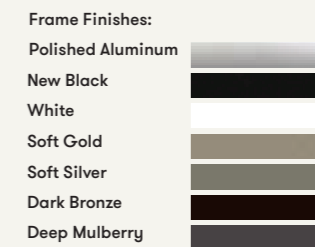

For larger swatches go to pg.188-205

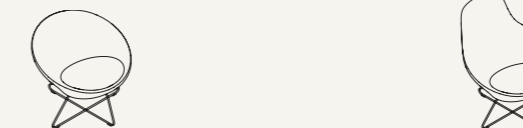

Famiglia

Design by Pearson Lloyd

62

63

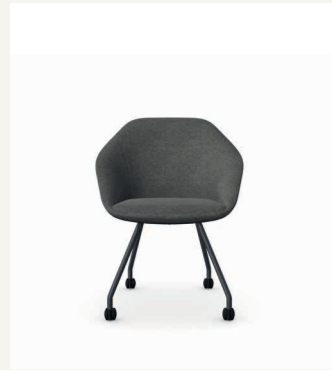

Famiglia - FMG1101
Low back on a 4 leg frame with casters

Dimensions:

Seat Height	18.75"
Seat Width	17.75"
Seat Depth	17.75"
Overall Height	32.5"
Overall Width	25.25"
Overall Depth	23.5"

- Standard Features:**
- Molded foam construction
 - Fully Upholstered
 - Tubular Steel Frame on 2" hard wheel casters finished in New Black powder coat

- Optional Features:**
- Tubular Steel frame available in a selection of powder coat finishes
 - 2" soft wheels casters
 - Two-tone Upholstery

Frame Finishes:

New Black	
White	
Soft Gold	
Soft Silver	
Dark Bronze	
Deep Mulberry	

For larger swatches go to pg.188-205

Famiglia - FMG1102
Low back chair on a 4 leg frame

Dimensions:

Seat Height	17.75"
Seat Width	17.75"
Seat Depth	17.75"
Overall Height	31.5"
Overall Width	25.25"
Overall Depth	23.5"

- Standard Features:**
- Molded foam construction
 - Fully Upholstered
 - Tubular Steel Frame finished in New Black powder coat
 - Plastic Glides

- Optional Features:**
- Tubular Steel frame available in a selection of powder coat finishes
 - Plastic Glides with felt
 - Two-tone Upholstery

Frame Finishes:

New Black	
White	
Soft Gold	
Soft Silver	
Dark Bronze	
Deep Mulberry	

For larger swatches go to pg.188-205

Famiglia - FMG1103
Low back chair on wood legs

Dimensions:

Seat Height	18"
Seat Width	17.75"
Seat Depth	17.75"
Overall Height	32"
Overall Width	25.25"
Overall Depth	23.5"

- Standard Features:**
- Molded foam construction
 - Fully Upholstered
 - Aluminum leg connector frame finished in New Black powder coat
 - Solid Ash legs with a clear finish
 - Plastic Glides

- Optional Features:**
- Solid Ash legs can be stained or color washed
 - Plastic Glides with felt
 - Two-tone Upholstery

Frame Finish:

New Black	
Wood Stains based on Ash:	
Clear	
White Oak	
American Cherry	
American Walnut	
Dark Walnut	
Wenge	

For larger swatches go to pg.188-205

16 optional standard color washes based on Ash are also available please go to pg. 194 to see more.



↓ Scan here to discover more



↓ Scan here to discover more



Famiglia

Design by Pearson Lloyd

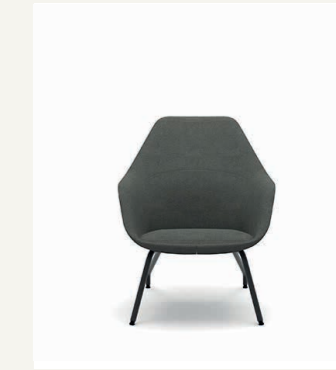

Famiglia - FMG1105
Low back chair on 4 star base glides

Dimensions:

Seat Height	18.25"
Seat Width	17.75"
Seat Depth	17.75"
Overall Height	32"
Overall Width	25.25"
Overall Depth	23.5"

- Standard Features:**
- Molded foam construction
 - Fully Upholstered
 - 4 star Aluminum swivel base on glides finished in New Black powder coat
 - Plastic Glides

- Optional Features:**
- Aluminum base available in a selection of powder coat finishes
 - 4 star auto return base on glides
 - Plastic Glides with felt
 - Two-tone Upholstery

Frame Finishes:

New Black	
White	
Soft Gold	
Soft Silver	
Dark Bronze	
Deep Mulberry	

For larger swatches go to pg.188-205

Famiglia - FMG1106
Low back chair on a 5 star base with casters

Dimensions:

Seat Height	20.25"
Seat Width	17.75"
Seat Depth	17.75"
Overall Height	33.75"
Overall Width	26"
Overall Depth	23.5"

- Standard Features:**
- Molded foam construction
 - Fully Upholstered
 - 5 star Aluminum swivel base with height adjustment on 2" hard wheel casters finished in New Black powder coat

- Optional Features:**
- Aluminum base available in a selection of powder coat finishes
 - 2" soft wheel casters
 - Two-tone Upholstery

Frame Finishes:

New Black	
White	
Soft Gold	
Soft Silver	
Dark Bronze	
Deep Mulberry	

For larger swatches go to pg.188-205

Famiglia - FMG1201
Mid back on a recliner frame

Dimensions:

Seat Height	15.25"
Seat Width	18.5"
Seat Depth	19"
Overall Height	33"
Overall Width	26.25"
Overall Depth	28.25"

- Standard Features:**
- Molded foam construction with dual density back foam
 - Fully Upholstered
 - Tubular Steel reclined frame finished in New Black powder coat
 - Plastic Glides

- Optional Features:**
- Tubular Steel frame available in a selection of powder coat finishes
 - Plastic Glides with felt
 - Two-tone Upholstery

Frame Finishes:

New Black	
White	
Soft Gold	
Soft Silver	
Dark Bronze	
Deep Mulberry	

For larger swatches go to pg.188-205



Famiglia

Design by Pearson Lloyd

64

65

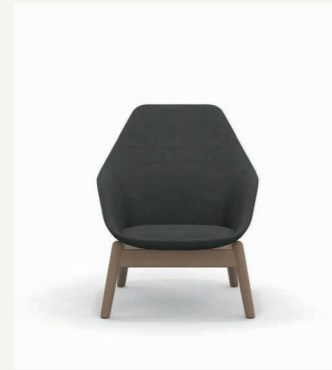

Famiglia - FMG1202
Mid back chair on a 4 leg frame

Dimensions:
 Seat Height 20.25"
 Seat Width 20.5"
 Seat Depth 22.25"
 Overall Height 38.5"
 Overall Width 26.25"
 Overall Depth 30.5"

- Standard Features:**
- Molded foam construction with dual density back foam
 - Fully Upholstered
 - Tubular Steel frame finished in New Black powder coat
 - Plastic Glides

- Optional Features:**
- Tubular Steel frame available in a selection of powder coat finishes
 - Plastic Glides with felt
 - Two-tone Upholstery

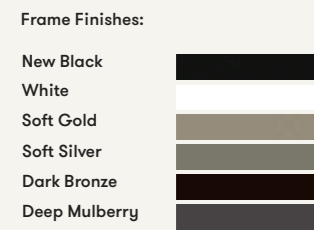

For larger swatches go to pg.188-205

Famiglia - FMG1203
Mid back chair on wood legs

Dimensions:
 Seat Height 14.75"
 Seat Width 18.5"
 Seat Depth 18.75"
 Overall Height 32"
 Overall Width 26.25"
 Overall Depth 28.75"

- Standard Features:**
- Molded foam construction with dual density back foam
 - Fully Upholstered
 - Solid Ash legs with a clear finish
 - Plastic Glides

- Optional Features:**
- Solid Ash legs can be stained or color washed
 - Plastic Glides with felt
 - Two-tone upholstery

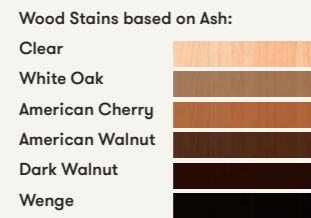

For larger swatches go to pg.188-205

16 optional standard color washes based on Ash are also available please go to pg. 194 to see more.

Famiglia - FMG1206
Mid back chair on a 5 star base with casters

Dimensions:
 Seat Height 21.5"
 Seat Width 18.5"
 Seat Depth 19.25"
 Overall Height 40"
 Overall Width 28"
 Overall Depth 26.75"

- Standard Features:**
- Molded foam construction with dual density back foam
 - Fully Upholstered
 - 5 star plastic base finished in Black
 - Dynamic free-floating recline and forward tilt with height adjustment
 - 2.5" hard wheel casters

- Optional Features:**
- 5 star Aluminum swivel base in Polished Aluminum
 - 2.5" soft wheel casters
 - Two-tone Upholstery

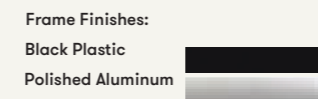

For larger swatches go to pg.188-205



↓ Scan here to discover more



↓ Scan here to discover more



Famiglia

Design by Pearson Lloyd



Famiglia - FMG1401
Lounge Chair on wire frame

Dimensions:
 Seat Height 16.25"
 Seat Width 21.5"
 Seat Depth 22"
 Overall Height 43"
 Overall Width 34.75"
 Overall Depth 33.5"

- Standard Features:**
- Molded foam construction with dual density back foam
 - Fully Upholstered
 - Tubular Steel frame finished in New Black powder coat
 - Plastic glides

- Optional Features:**
- Tubular Steel frame available in a selection of powder coat finishes
 - Plastic Glides with felt
 - Two-tone Upholstery

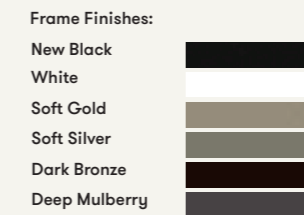

For larger swatches go to pg.188-205

Famiglia - FMG1403
Lounge Chair on wooden frame

Dimensions:
 Seat Height 16.25"
 Seat Width 21.5"
 Seat Depth 22"
 Overall Height 42.5"
 Overall Width 34.75"
 Overall Depth 33.5"

- Standard Features:**
- Molded foam construction with dual density back foam
 - Fully Upholstered
 - Solid Ash legs with a clear finish
 - Plastic glides

- Optional Features:**
- Solid Ash legs can be stained or color washed
 - Plastic Glides with felt
 - Two-tone upholstery



For larger swatches go to pg.188-205

16 optional standard color washes based on Ash are also available please go to pg. 194 to see more.

Famiglia - FMG1405
Lounge chair on a 4 star swivel blade base

Dimensions:
 Seat Height 16.75"
 Seat Width 21.5"
 Seat Depth 22"
 Overall Height 43.25"
 Overall Width 34.75"
 Overall Depth 35.75"

- Standard Features:**
- Molded foam construction with dual density back foam
 - Fully Upholstered
 - 4 Star Aluminum auto return swivel base in New Black powder coat
 - Plastic glides

- Optional Features:**
- 4 Star Aluminum auto return swivel available in a selection of powder coat finishes
 - 4 Star Aluminum auto return swivel available in Polished Aluminum
 - Two-tone upholstery

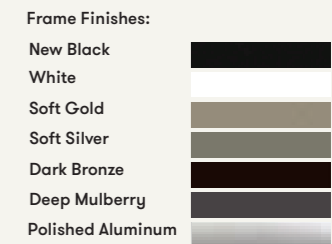

For larger swatches go to pg.188-205



Famiglia

Design by Pearson Lloyd

66

67

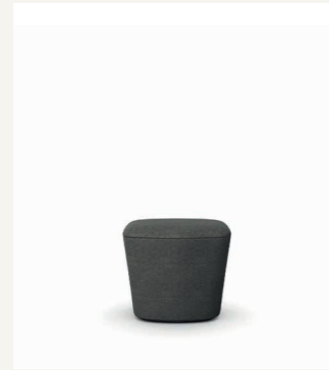

Famiglia - FMG-1501
High back on reclining frame

Dimensions:
 Seat Height 15.75"
 Seat Width 19.50"
 Seat Depth 20.75"
 Overall Height 46.25"
 Overall Width 29.5"
 Overall Depth 32.75"

Standard Features:
 — Molded foam construction with dual density back foam
 — Fully Upholstered
 — Tubular Steel reclined frame finished in New Black powder coat
 — Plastic Glides

Optional Features:
 — Tubular Steel frame available in a selection of powder coat finishes
 — Plastic glides with felt
 — Two-tone upholstery

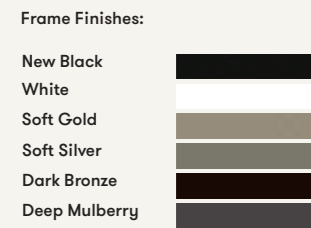

For larger swatches go to pg.188-205

Famiglia - FMG-1505
High back on 4 star swivel base

Dimensions:
 Seat Height 16.25"
 Seat Width 19.50"
 Seat Depth 20.75"
 Overall Height 47"
 Overall Width 34"
 Overall Depth 35.50"

Standard Features:
 — Molded foam construction with dual density back foam
 — Fully Upholstered
 — 4 star Aluminum auto return swivel base finished in New Black powder coat
 — Plastic Glides

Optional Features:
 — 4 star Aluminum auto return swivel base available in a selection of powder coat finishes.
 — 4 star Aluminum auto return swivel base available in Polished Aluminum
 — Plastic glides with felt
 — Two-tone upholstery

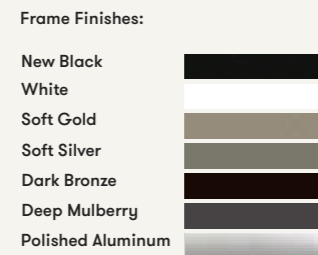

For larger swatches go to pg.188-205

Famiglia - FMGFS
Footstool

Dimensions:
 Seat Height 17"
 Seat Width 20"
 Seat Depth 17.25"
 Overall Height 17"
 Overall Width 20"
 Overall Depth 17.25"

Standard Features:
 — Molded foam construction
 — Fully Upholstered

Optional Features:
 — Two-tone upholstery



↓ Scan here to discover more



↓ Scan here to discover more



Fifty Series

Design by Allermuir Design Studio

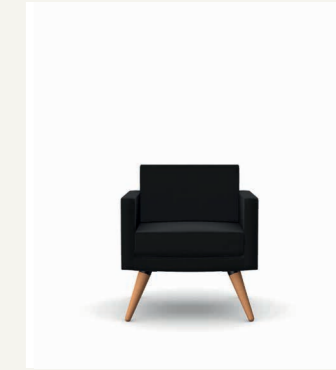
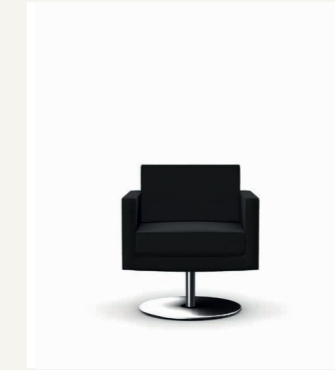
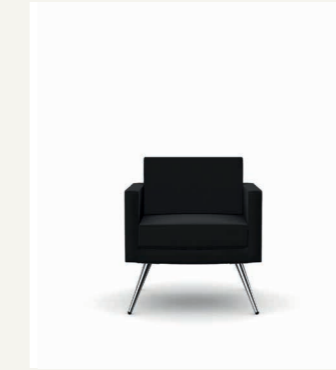

Fifty Series - FIFT01
Armchair on swaged legs

Dimensions:
 Seat Height 18.5"
 Seat Width 21.75"
 Seat Depth 18"
 Overall Height 30.5"
 Overall Width 27.5"
 Overall Depth 28"

Standard Features:
 — Traditional carcass construction
 — Webbed seat support
 — Fully upholstered
 — Swaged Tubular Steel legs finished in Polished Chrome
 — Plastic glides

Optional Features:
 — Two-tone upholstery

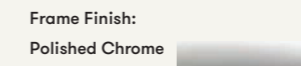

For larger swatches go to pg.188-205

Fifty Series - FIFT04
Armchair on a swivel pedestal base

Dimensions:
 Seat Height 18.5"
 Seat Width 21.75"
 Seat Depth 18"
 Overall Height 30.5"
 Overall Width 27.5"
 Overall Depth 28"

Standard Features:
 — Traditional carcass construction
 — Webbed seat support
 — Fully upholstered
 — Steel swivel pedestal base finished in Polished Chrome
 — Plastic glides

Optional Features:
 — Two-tone upholstery

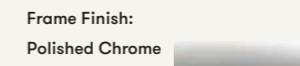

For larger swatches go to pg.188-205

Fifty Series - FIFT05
Armchair on conical legs

Dimensions:
 Seat Height 18.5"
 Seat Width 21.75"
 Seat Depth 18"
 Overall Height 30.5"
 Overall Width 27.5"
 Overall Depth 28"

Standard Features:
 — Traditional carcass construction
 — Webbed seat support
 — Fully upholstered
 — Solid Beech conical legs with a clear finish
 — Plastic glides

Optional Features:
 — Solid beech conical legs can be stained or color washed
 — Two-tone upholstery

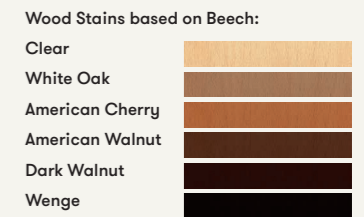

For larger swatches go to pg.188-205

16 optional standard color washes based on Beech are also available please go to pg. 194 to see more.

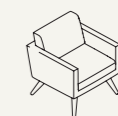
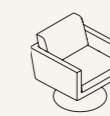
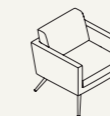

Fifty Series

Design by Allermuir Design Studio

68

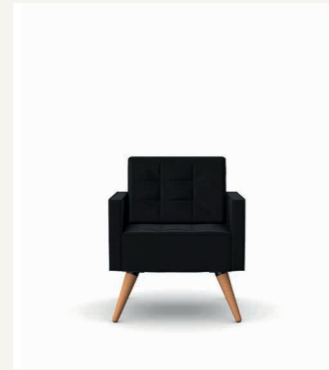
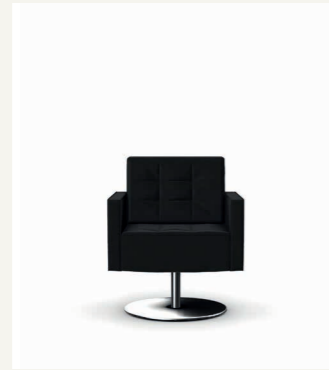
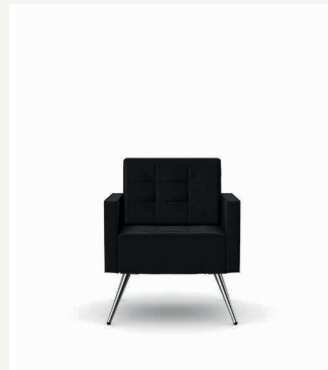

Fifty Series - FIFT11
Arm chair - High back, tufted seat and back upholstery, metal leg

Dimensions:
 Seat Height 18.5"
 Seat Width 21.75"
 Seat Depth 18"
 Overall Height 31.5"
 Overall Width 27.5"
 Overall Depth 28"

- Standard Features:
- Traditional carcass construction
 - Webbed seat support
 - Fully upholstered
 - Tufted seat and back upholstery
 - High back
 - Swaged Tubular Steel legs finished in Polished Chrome
 - Plastic glides

- Optional Features:
- Two-tone upholstery

Frame Finish:
 Polished Chrome 

For larger swatches go to pg.188-205

Fifty Series - FIFT14
Arm chair - High back, tufted seat and back upholstery, pedestal base

Dimensions:
 Seat Height 18.5"
 Seat Width 21.75"
 Seat Depth 18"
 Overall Height 31.5"
 Overall Width 27.5"
 Overall Depth 28"

- Standard Features:
- Traditional carcass construction
 - Webbed seat support
 - Fully upholstered
 - Tufted seat and back upholstery
 - High back
 - Steel swivel pedestal based finished in polished chrome
 - Plastic glides

- Optional Features:
- Two-tone upholstery

Frame Finish:
 Polished Chrome 

For larger swatches go to pg.188-205







Fifty Series - FIFT15
Arm chair - High back, tufted seat and back upholstery, wood legs

Dimensions:
 Seat Height 18.5"
 Seat Width 21.75"
 Seat Depth 18"
 Overall Height 31.5"
 Overall Width 27.5"
 Overall Depth 28"

- Standard Features:
- Traditional carcass construction
 - Webbed seat support
 - Fully upholstered
 - Tufted seat and back upholstery
 - High back
 - Solid Beech conical legs with a clear finish

- Optional Features:
- Solid Beech conical legs can be stained or color washed
 - Two-tone upholstery

Wood Stains based on Beech:

- Clear 
- White Oak 
- American Cherry 
- American Walnut 
- Dark Walnut 
- Wenge 

For larger swatches go to pg.188-205

16 optional standard color washes based on Beech are also available please go to pg. 194 to see more.

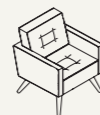
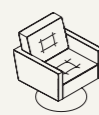
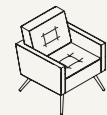

↓ Scan here to discover more



↓ Scan here to discover more



Fifty Series

Design by Allermuir Design Studio

69

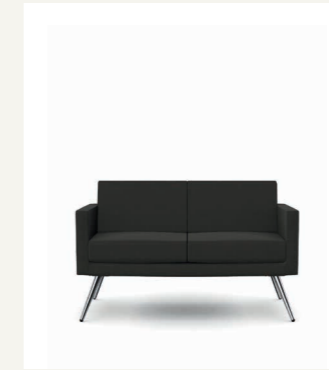

Fifty Series - FIFT02
Two seat sofa on swaged legs

Dimensions:
 Seat Height 18.5"
 Seat Width 43.5"
 Seat Depth 18"
 Overall Height 30.5"
 Overall Width 50.5"
 Overall Depth 28"

- Standard Features:
- Traditional carcass construction
 - Webbed seat support
 - Fully upholstered
 - Swaged Tubular Steel legs finished in Polished Chrome
 - Plastic glides

- Optional Features:
- Two-tone upholstery

Frame Finish:
 Polished Chrome 

For larger swatches go to pg.188-205





Fifty Series - FIFT06
Two seat sofa on conical legs

Dimensions:
 Seat Height 18.5"
 Seat Width 43.5"
 Seat Depth 18"
 Overall Height 30.5"
 Overall Width 50.5"
 Overall Depth 28"

- Standard Features:
- Traditional carcass construction
 - Webbed seat support
 - Fully upholstered
 - Solid Beech conical legs with a clear finish

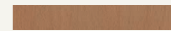
- Optional Features:
- Solid Beech conical legs can be stained or color washed
 - Two-tone upholstery

Wood Stains based on Beech:

- Clear 
- White Oak 
- American Cherry 
- American Walnut 
- Dark Walnut 
- Wenge 

For larger swatches go to pg.188-205

16 optional standard color washes based on Beech are also available please go to pg. 194 to see more.



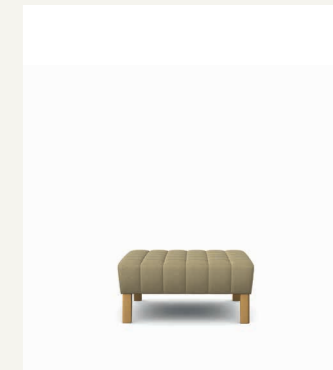
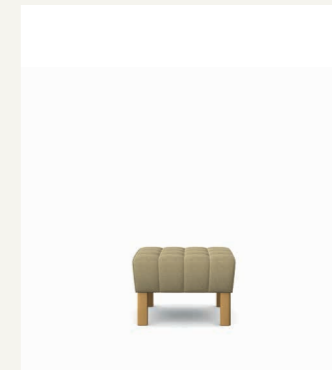
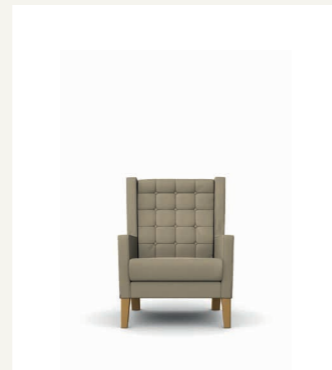
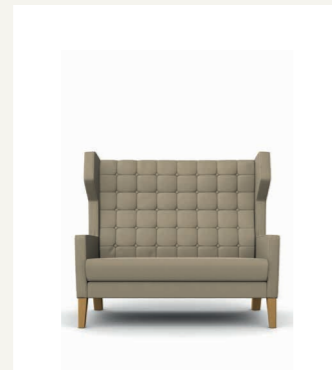
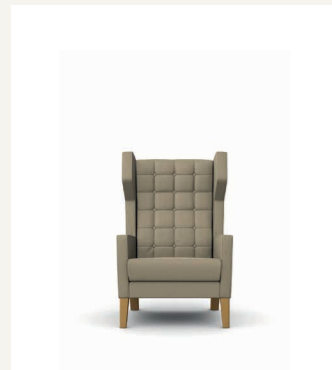

Grainger - GR1
High backed winged armchair

Dimensions:
 Seat Height 18.5"
 Seat Width 22.75"
 Seat Depth 20"
 Overall Height 46"
 Overall Width 29.75"
 Overall Depth 34.5"

- Standard Features:
- Traditional carcass construction
 - Secured deep buttoned back cushion
 - Webbed seat support
 - Solid Oak legs with a clear finish

- Optional Features:
- Solid Oak legs can be stained or color washed
 - Two-tone upholstery

Wood Stains based on Oak:



For larger swatches go to pg.188-205

16 optional standard color washes based on Oak are also available please go to pg. 194 to see more.

Grainger - GR2
High backed winged two seat sofa

Dimensions:
 Seat Height 18.5"
 Seat Width 45.75"
 Seat Depth 20"
 Overall Height 46"
 Overall Width 53.25"
 Overall Depth 34.5"

- Standard Features:
- Traditional carcass construction
 - Secured deep buttoned back cushion
 - Webbed seat support
 - Solid Oak legs with a clear finish

- Optional Features:
- Solid Oak legs can be stained or color washed
 - Two-tone upholstery

Wood Stains based on Oak:



For larger swatches go to pg.188-205

16 optional standard color washes based on Oak are also available please go to pg. 194 to see more.

Grainger - GR3
Low backed armchair

Dimensions:
 Seat Height 18.5"
 Seat Width 22.75"
 Seat Depth 20"
 Overall Height 40.25"
 Overall Width 29.5"
 Overall Depth 33.5"

- Standard Features:
- Traditional carcass construction
 - Secured deep buttoned back cushion
 - Webbed seat support
 - Solid Oak legs with a clear finish

- Optional Features:
- Solid Oak legs can be stained or color washed
 - Two-tone upholstery

Wood Stains based on Oak:



For larger swatches go to pg.188-205

16 optional standard color washes based on Oak are also available please go to pg. 194 to see more.

Grainger - GR4
Low backed two seat sofa

Dimensions:
 Seat Height 18.5"
 Seat Width 45.75"
 Seat Depth 20"
 Overall Height 40.25"
 Overall Width 53.25"
 Overall Depth 33.5"

- Standard Features:
- Traditional carcass construction
 - Secured deep buttoned back cushion
 - Webbed seat support
 - Solid Oak legs with a clear finish

- Optional Features:
- Solid Oak legs can be stained or color washed
 - Two-tone upholstery

Wood Stains based on Oak:



For larger swatches go to pg.188-205

16 optional standard color washes based on Oak are also available please go to pg. 194 to see more.

Grainger - GR7
Small ottoman

Dimensions:
 Overall Height 15.25"
 Overall Width 24"
 Overall Depth 24"

- Standard Features:
- Traditional carcass construction
 - Webbed seat support
 - Solid Oak legs with a clear finish

- Optional Features:
- Solid Oak legs can be stained or color washed
 - Two-tone upholstery

Wood Stains based on Oak:



For larger swatches go to pg.188-205

16 optional standard color washes based on Oak are also available please go to pg. 194 to see more.

Grainger - GR8
Large ottoman

Dimensions:
 Overall Height 15.25"
 Overall Width 34"
 Overall Depth 34"

- Standard Features:
- Traditional carcass construction
 - Webbed seat support
 - Solid Oak legs with a clear finish

- Optional Features:
- Solid Oak legs can be stained or color washed
 - Two-tone upholstery

Wood Stains based on Oak:



For larger swatches go to pg.188-205

16 optional standard color washes based on Oak are also available please go to pg. 194 to see more.

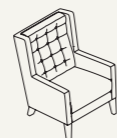
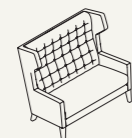

↓ Scan here to discover more



↓ Scan here to discover more

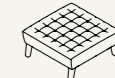
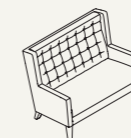

Haven



Design by Mark Gabbertas

72

73

Haven

Standard Features:

- Molded foam construction
- Webbed seat support
- Fully upholstered
- Aluminum frame finished in Black (Textured) powder coat
- Plastic glides

Optional Features:

- Under frame power unit (2x powered USB/TUF and 1x power socket)
- Two-tone upholstery
- HALD, seat linking device available on select models only

Frame Finish:

Black (Textured) 

For larger swatches go to pg.188-205



HA102
OH: 31.25"
OW: 44.75"
OD: 32"



HA202
OH: 31.25"
OW: 78.75"
OD: 32"



HAM100
OH: 31.25"
OW: 30"
OD: 32"



HAM101RH
OH: 31.25"
OW: 39.5"
OD: 32"



HAM101LH
OH: 31.25"
OW: 39.5"
OD: 32"



HA102HR
OH: 47"
OW: 44.75"
OD: 32"



HAM200
OH: 31.25"
OW: 60.25"
OD: 32"



HAM201LH
OH: 31.25"
OW: 71.75"
OD: 32"



HAM201RH
OH: 31.25"
OW: 71.75"
OD: 32"



HAM100HR
OH: 47"
OW: 30"
OD: 32"



HAM101HRLH
OH: 47"
OW: 39.5"
OD: 32"



HAM101HRRH
OH: 47"
OW: 39.5"
OD: 32"

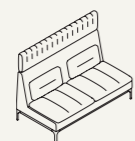

HAM200HR
OH: 47"
OW: 60.25"
OD: 32"



HAM201HRRH
OH: 47"
OW: 71.75"
OD: 32"



HAM201HRLH
OH: 47"
OW: 71.75"
OD: 32"



HA202HR
OH: 47"
OW: 78.75"
OD: 32"



HAO104
OH: 17"
OW: 30.75"
OD: 22.75"

Configurations:

Create your own using our product configurator at allermuir.com

1. HAM101RH
HAM100
HAM101LH

1

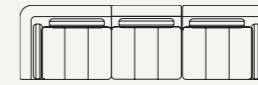

2

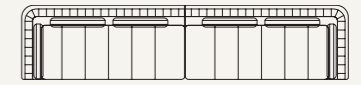

2. HAM201HRRH
HAM201HRLH

3. HAM201HRRH
HAM101HRLH
HAM201HRLH

3

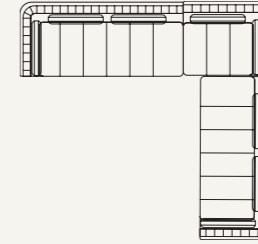

4

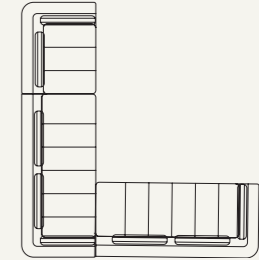

4. HAM201RH x 2
HAM101LH

5. HAM201RH x 2
HAM100
HAM201LH x 2

5

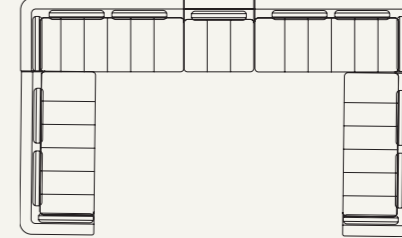

6

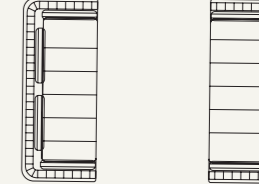

6. HA200HR
HA200HR

7. HAM201HRRH x 2
HAM100HR x 2
HAM201HRLH

7

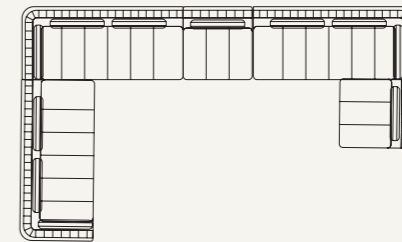

↓ Scan here to discover more



Haven Bench

Design By Mark Gabbertas

74

75

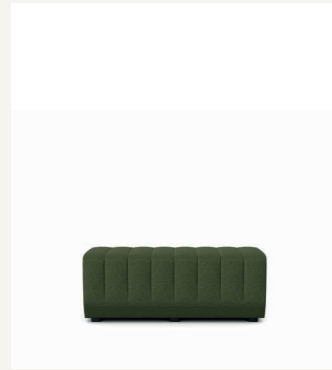

Haven Bench

Standard Features:

- Traditional carcass construction
- Fully upholstered bench with quilted detail
- Plastic glides
- Steel frame finished in Black (Textured) powder coat
- Black casters
- Available in 3 sizes - 47.25", 59" and 71"

Optional Features:

- Plastic glides with felt
- Bench to bench linking options available on select models

Frame Finish:

Black (Textured) 

For larger swatches go to pg.188-205

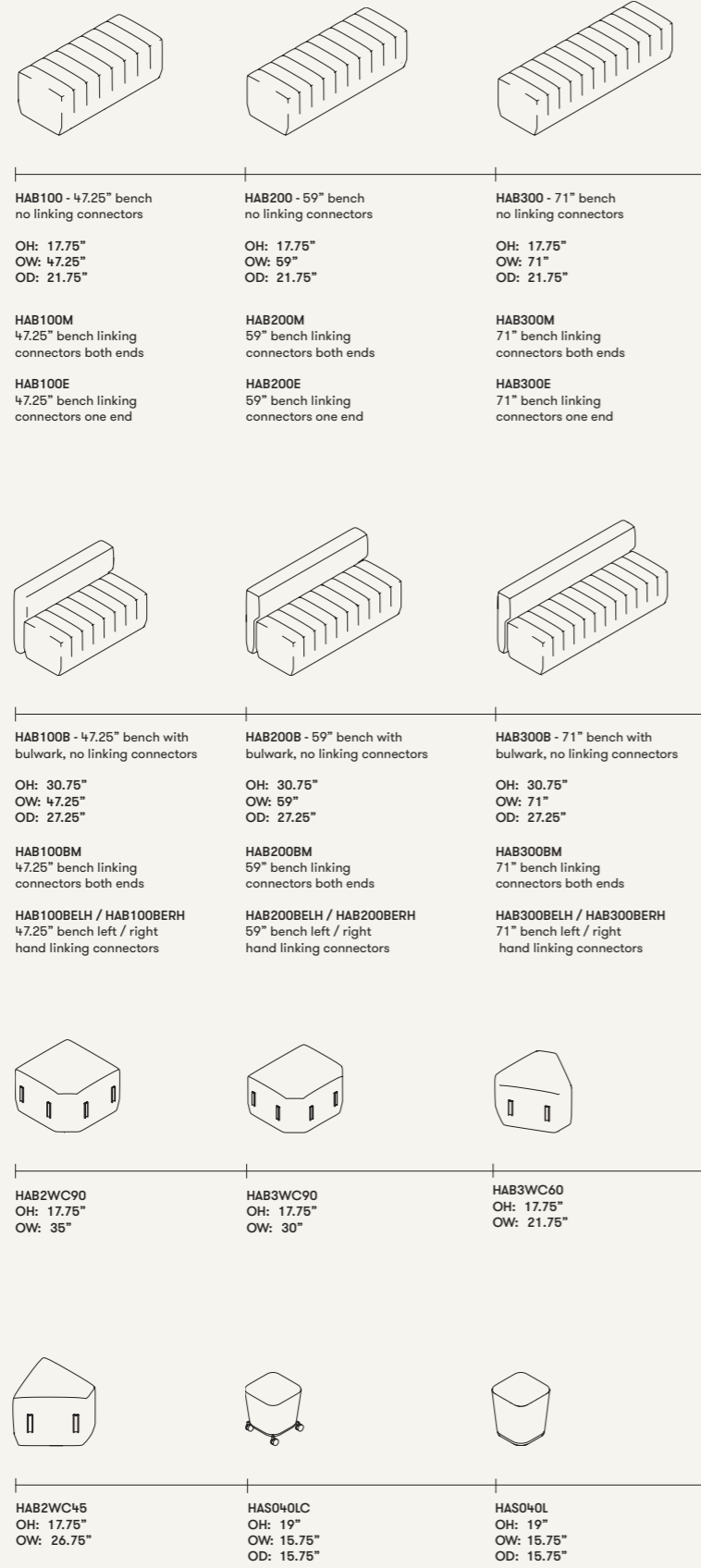

Configurations:

Create your own using our product configurator at allermuir.com

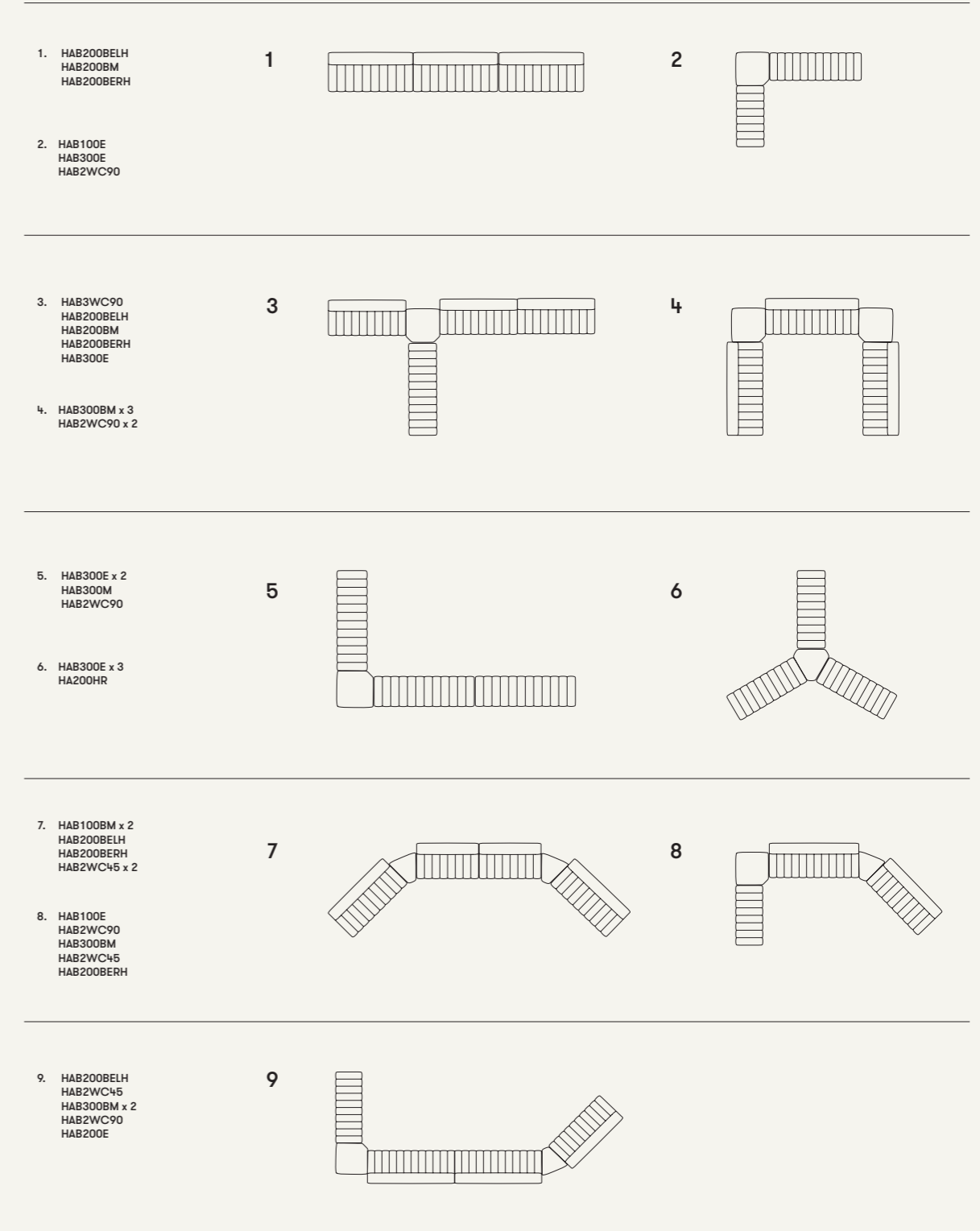

↓ Scan here to discover more



Jinx

Design by Allermuir Design Studio

76

77

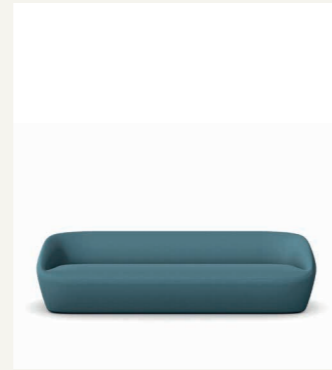
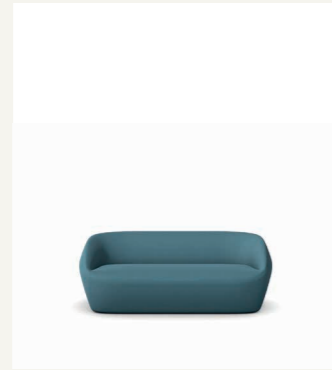
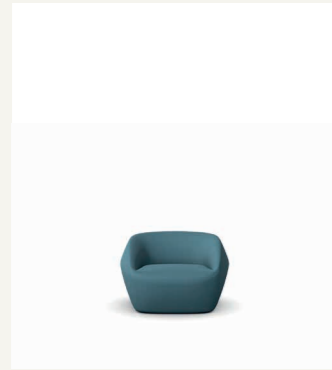

Jinx - JNX01
Lounge chair

Dimensions:
 Seat Height 16.25"
 Seat Width 21.75"
 Seat Depth 22.5"
 Overall Height 26.25"
 Overall Width 39.5"
 Overall Depth 38"

- Standard Features:
- Wood carcass construction
 - Dual density back foam
 - Sprung seat foam
 - Fully upholstered
 - Plastic glides

- Optional Features:
- Solid ash side shelf with a clear finish
 - Ash side shelf can be stained or color washed
 - Swivel base
 - Plastic glides with felt
 - Two-tone upholstery

Wood Stains based on Ash:



For larger swatches go to pg.188-205

16 optional standard color washes based on Ash are also available please go to pg. 194 to see more.

Jinx - JNX02
2 seat sofa

Dimensions:
 Seat Height 16.25"
 Seat Width 56.25"
 Seat Depth 22.5"
 Overall Height 26.25"
 Overall Width 73"
 Overall Depth 38"

- Standard Features:
- Wood carcass construction
 - Dual density back foam
 - Sprung seat foam
 - Fully upholstered
 - Plastic glides

- Optional Features:
- Plastic glides available with felt
 - Two-tone upholstery

Jinx - JNX03
3 seat sofa

Dimensions:
 Seat Height 16.25"
 Seat Width 84"
 Seat Depth 22.5"
 Overall Height 26.25"
 Overall Width 100"
 Overall Depth 38"

- Standard Features:
- Wood carcass construction
 - Dual density back foam
 - Sprung seat foam
 - Fully upholstered
 - Plastic glides

- Optional Features:
- Plastic glides available with felt
 - Two-tone upholstery



↓ Scan here to discover more



↓ Scan here to discover more



Lola

Design by Wolfgang C. R. Mezger

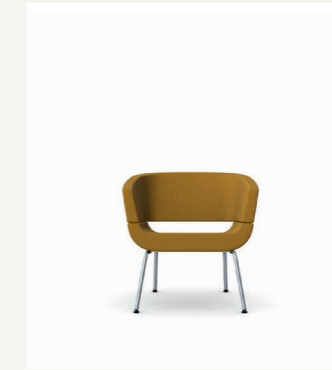
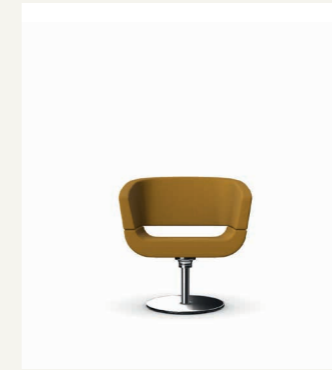

Lola - A820
Lounge chair on swivel pedestal base

Dimensions:
 Seat Height 17.25"
 Seat Width 22"
 Seat Depth 19.25"
 Overall Height 29.25"
 Overall Width 30.5"
 Overall Depth 26.5"

- Standard Features:
- Molded foam construction
 - Fully upholstered
 - Steel swivel pedestal base finished in Polished Chrome

- Optional Features:
- Two-tone upholstery

Frame Finish:

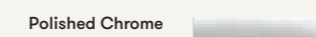

For larger swatches go to pg.188-205

Lola - A821
Lounge chair on 4 leg frame

Dimensions:
 Seat Height 17.25"
 Seat Width 22"
 Seat Depth 19.25"
 Overall Height 29.25"
 Overall Width 30.5"
 Overall Depth 26.5"

- Standard Features:
- Molded foam construction
 - Fully upholstered
 - Tubular steel frame finished in Silver M04 powder coat
 - Plastic self-leveling glides

- Optional Features:
- Tubular steel frame available in Polished Chrome
 - Plastic self-leveling glides with felt
 - Two-tone upholstery

Frame Finish:

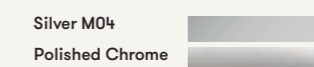

For larger swatches go to pg.188-205

Lola - A825
Lounge chair on 4 leg wooden frame

Dimensions:
 Seat Height 17.25"
 Seat Width 22"
 Seat Depth 19.25"
 Overall Height 29.25"
 Overall Width 30.5"
 Overall Depth 26.5"

- Standard Features:
- Molded foam construction
 - Fully upholstered
 - Solid Beech legs with a clear finish
 - Plastic glides

- Optional Features:
- Solid Beech legs can be stained or color washed
 - Solid Oak legs with a clear finish
 - Two-tone upholstery
 - Plastic glides with felt

Solid Wood Finishes:



For larger swatches go to pg.188-205

Wood Stains based on Beech:

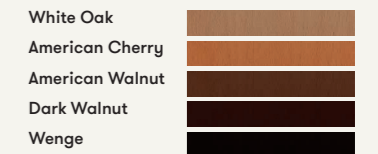

For larger swatches go to pg.188-205

16 optional standard color washes based on Beech are also available please go to pg. 194 to see more.



Lola

Design by Wolfgang C. R. Mezger

78

79

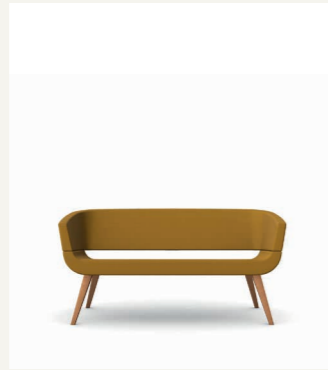
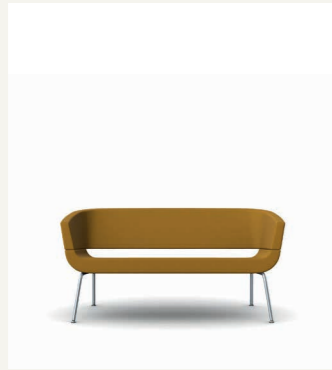

Lola - A822 Sofa on a ¼ leg frame

Dimensions:

Seat Height	17.25"
Seat Width	52"
Seat Depth	19.25"
Overall Height	29.25"
Overall Width	60"
Overall Depth	26.5"

Standard Features:

- Molded foam construction
- Fully upholstered
- Tubular steel frame finished in Silver M04 powder coat
- Plastic self-leveling glides

Optional Features:

- Tubular steel frame available in Polished Chrome
- Plastic self-leveling glides with felt
- Two-tone upholstery

Frame Finish:

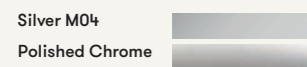

For larger swatches go to pg.188-205

Lola - A826 Sofa on ¼ leg wooden frame

Dimensions:

Seat Height	17.25"
Seat Width	52"
Seat Depth	19.25"
Overall Height	29.25"
Overall Width	60"
Overall Depth	26.5"

Standard Features:

- Molded foam construction
- Fully upholstered
- Solid Beech legs with a clear finish
- Plastic glides

Optional Features:

- Solid Beech legs can be stained or color washed
- Solid Oak legs with a clear finish
- Two-tone upholstery
- Plastic glides with felt

Solid Wood Finishes:



Wood Stains based on Beech:

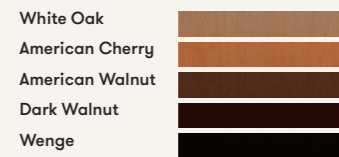

For larger swatches go to pg.188-205

16 optional standard color washes based on Beech are also available please go to pg. 194 to see more.



↓ Scan here to discover more



↓ Scan here to discover more



Mayze Mobile

Design by Allermuir Design Studio

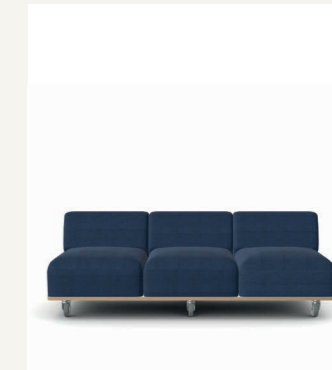
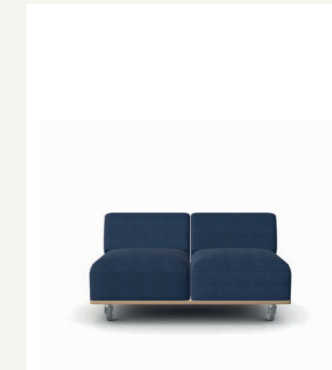
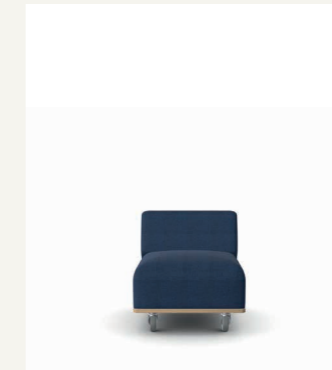

Mayze Mobile - MZE100C Single Seat

Dimensions:

Seat Height	15.25"
Seat Width	26.5"
Seat Depth	26.5"
Overall Height	27.75"
Overall Width	26.5"
Overall Depth	34.5"

Standard Features:

- Traditional carcass construction
- Tensioned seat support
- 1" Plywood base with a clear edge finish
- Metal soft casters with non-skid wheels in gray

Optional Features:

- Two-tone upholstery
- Red Soft Casters

Mayze Mobile - MZE200C Two Seat

Dimensions:

Seat Height	15.25"
Seat Width	53.25"
Seat Depth	26.5"
Overall Height	27.75"
Overall Width	52.25"
Overall Depth	34.5"

Standard Features:

- Traditional carcass construction
- Tensioned seat support
- 1" Plywood base with a clear edge finish
- Metal soft casters with non-skid wheels in gray

Optional Features:

- Two-tone upholstery
- Red Soft Casters

Mayze Mobile - MZE300C Three Seat

Dimensions:

Seat Height	15.25"
Seat Width	79.75"
Seat Depth	26.5"
Overall Height	27.75"
Overall Width	79.75"
Overall Depth	34.5"

Standard Features:

- Traditional carcass construction
- Tensioned seat support
- 1" Plywood base with a clear edge finish
- Metal soft casters with non-skid wheels in gray

Optional Features:

- Two-tone upholstery
- Red Soft Casters

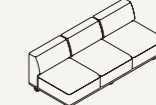
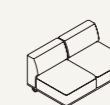

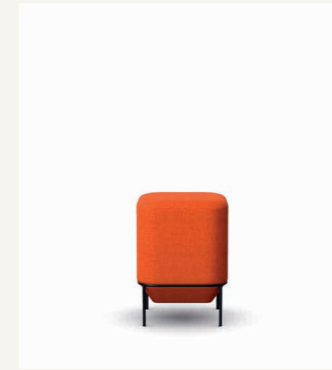
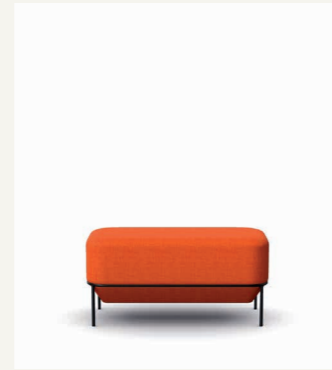
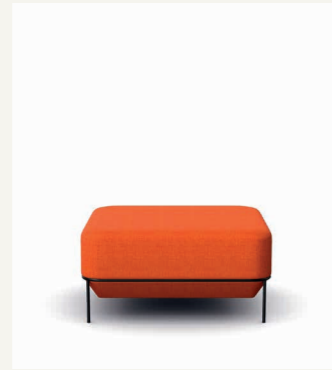
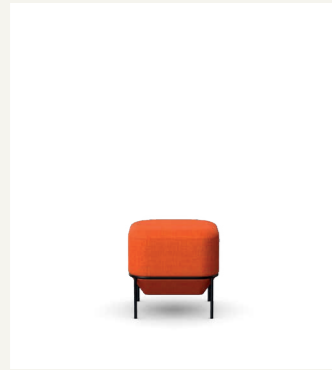

Mozaik - MZK101
Low square stool, small

Dimensions:
Overall Height 16.5"
Overall Width 17.25"
Overall Depth 17.25"

- Standard Features:
- Traditional carcass construction
 - Fully upholstered
 - Wire frame finished in Black powder coat
 - Plastic glides

- Optional Features:
- Wire frame available in a White powder coat finish
 - Two tone upholstery

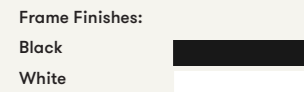

For larger swatches go to pg.188-205

Mozaik - MZK102
Large low square stool

Dimensions:
Overall Height 16.5"
Overall Width 34"
Overall Depth 34"

- Standard Features:
- Traditional carcass construction
 - Fully upholstered
 - Wire frame finished in Black powder coat
 - Plastic glides

- Optional Features:
- Wire frame available in a White powder coat finish
 - Two tone upholstery

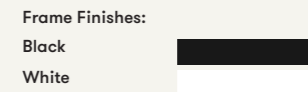

For larger swatches go to pg.188-205

Mozaik - MZK103
Low rectangular bench

Dimensions:
Overall Height 16.5"
Overall Width 17.25"
Overall Depth 34"

- Standard Features:
- Traditional carcass construction
 - Fully upholstered
 - Wire frame finished in Black powder coat
 - Plastic glides

- Optional Features:
- Wire frame available in a White powder coat finish
 - Two tone upholstery

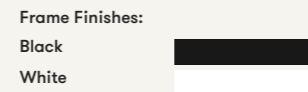

For larger swatches go to pg.188-205

Mozaik - MZK201
Small high square stool

Dimensions:
Overall Height 23.5"
Overall Width 17.25"
Overall Depth 17.25"

- Standard Features:
- Traditional carcass construction
 - Fully upholstered
 - Wire frame finished in Black powder coat
 - Plastic glides

- Optional Features:
- Wire frame available in a White powder coat finish
 - Two tone upholstery



For larger swatches go to pg.188-205

Mozaik - MZK203
High rectangular bench

Dimensions:
Overall Height 23.5"
Overall Width 17.25"
Overall Depth 34"

- Standard Features:
- Traditional carcass construction
 - Fully upholstered
 - Wire frame finished in Black powder coat
 - Plastic glides

- Optional Features:
- Wire frame available in a White powder coat finish
 - Two tone upholstery



For larger swatches go to pg.188-205



↓ Scan here to discover more



↓ Scan here to discover more



Open

Design By Pearson Lloyd

82

83

Open

Design By Pearson Lloyd

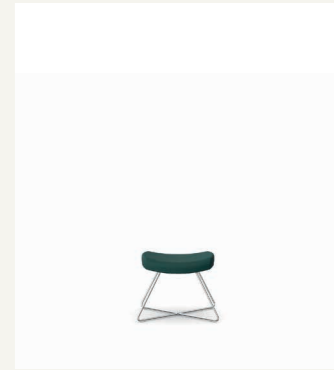
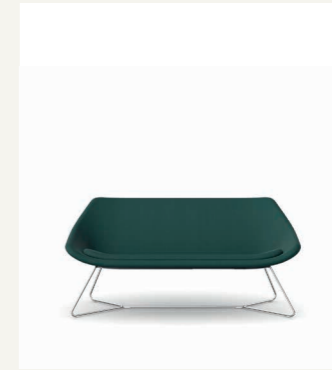
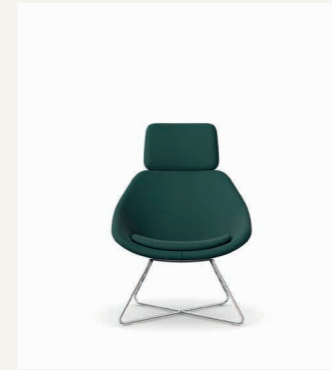
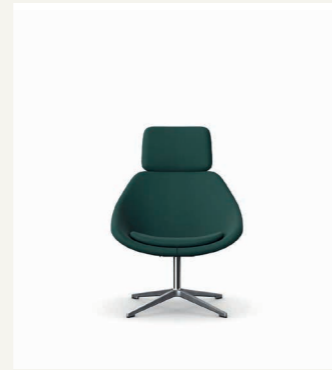
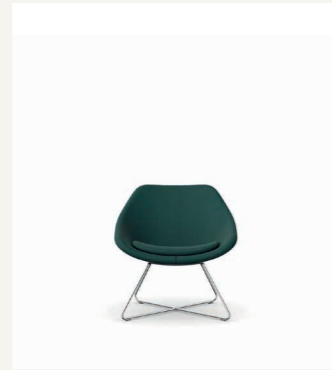
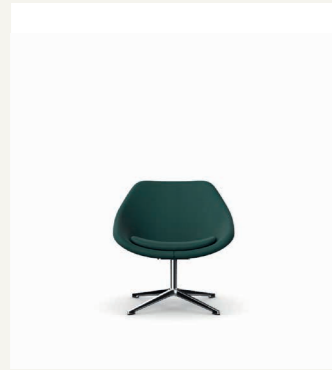

Open - OPN104
Lounge chair on a 4 star swivel base

Dimensions:

Seat Height	18"
Seat Width	18"
Seat Depth	19.75"
Overall Height	30.25"
Overall Width	30.75"
Overall Depth	33.75"

- Standard Features:
- Molded foam construction
 - Fully upholstered
 - 4 star Aluminum auto return swivel base finished in New Black powder coat
 - Plastic glides

- Optional Features:
- 4 star auto return swivel base available in Polished Aluminum and a selection of powder coat finishes
 - Two-tone upholstery

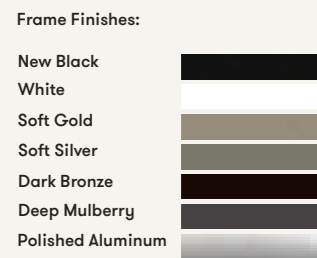

For larger swatches go to pg.188-205

Open - OPN108
Lounge chair on a wire frame

Dimensions:

Seat Height	18"
Seat Width	18"
Seat Depth	19.75"
Overall Height	30.25"
Overall Width	29.25"
Overall Depth	31.5"

- Standard Features:
- Molded foam construction
 - Fully upholstered
 - Wire frame finished in New Black powder coat
 - Plastic glides

- Optional Features:
- Wire frame available in a selection of powder coat finishes or polished chrome
 - Two-tone upholstery

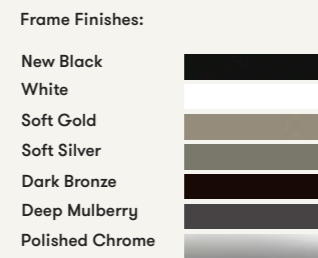

For larger swatches go to pg.188-205

Open - OPN154
Lounge chair with headrest on a 4 star swivel base

Dimensions:

Seat Height	18"
Seat Width	18"
Seat Depth	19.75"
Overall Height	41.25"
Overall Width	30.75"
Overall Depth	33.75"

- Standard Features:
- Molded foam construction
 - Fully upholstered
 - 4 star Aluminum auto return swivel base finished in New Black powder coat
 - Plastic glides

- Optional Features:
- 4 star auto return swivel base available in Polished Aluminum and a selection of powder coat finishes
 - Two-tone upholstery

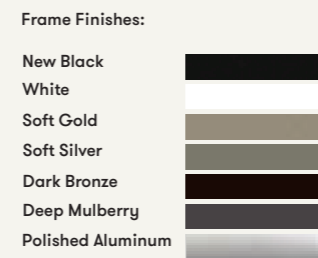

For larger swatches go to pg.188-205

Open - OPN158
Lounge chair with headrest on a wire frame

Dimensions:

Seat Height	18"
Seat Width	18"
Seat Depth	19.75"
Overall Height	41.25"
Overall Width	29.25"
Overall Depth	31.5"

- Standard Features:
- Molded foam construction
 - Fully upholstered
 - Wire frame finished in New Black powder coat
 - Plastic glides

- Optional Features:
- Wire frame available in a selection of powder coat finishes or Polished Chrome
 - Two-tone upholstery

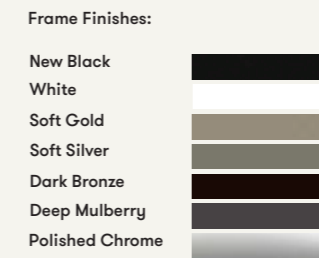

For larger swatches go to pg.188-205

Open - OPN208
Sofa on a wire frame

Dimensions:

Seat Height	18"
Seat Width	51.25"
Seat Depth	19.75"
Overall Height	30.25"
Overall Width	63"
Overall Depth	31.5"

- Standard Features:
- Molded foam construction
 - Fully upholstered
 - Wire frame finished in New Black powder coat
 - Plastic glides

- Optional Features:
- Wire frame available in a selection of powder coat finishes or Polished Chrome
 - Two-tone upholstery

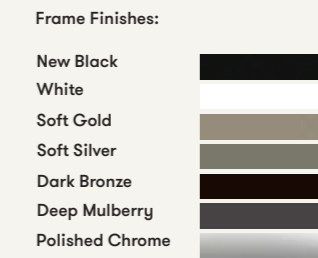

For larger swatches go to pg.188-205

Open - OPNFS8
Footstool on a wire frame

Dimensions:

Seat Height	17.25"
Seat Width	21.75"
Seat Depth	20"
Overall Height	17.25"
Overall Width	21.75"
Overall Depth	20"

- Standard Features:
- Molded foam construction
 - Fully upholstered
 - Wire frame finished in New Black powder coat
 - Plastic glides

- Optional Features:
- Wire frame available in a selection of powder coat finishes or Polished Chrome

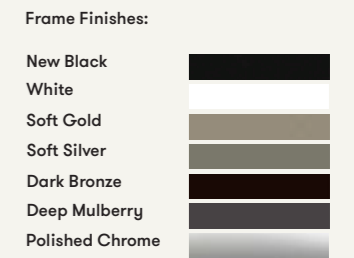

For larger swatches go to pg.188-205



↓ Scan here to discover more



↓ Scan here to discover more

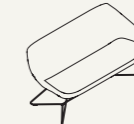

Pause

Design by Allermuir Design Studio

84

85

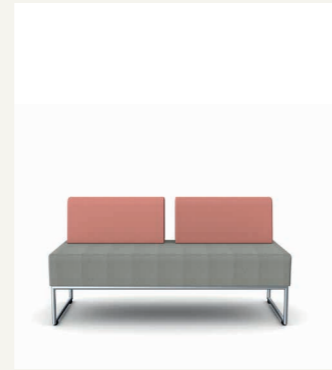
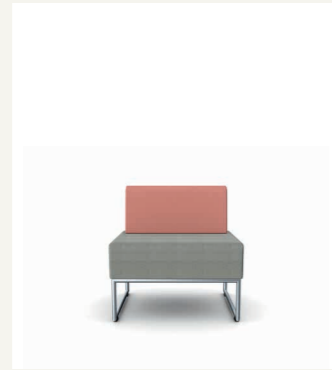
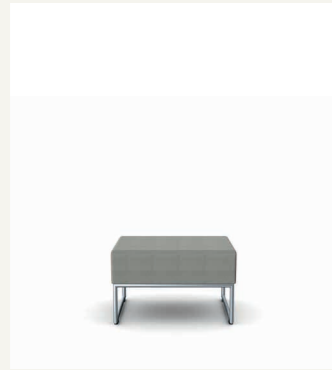

Pause - PSM100 Single seat unit

Standard Features:

- Traditional carcass construction
- Molded foam back construction
- Tubular steel frame finished in Silver M04 powder coat
- Plastic glides with leveling adjustment

Optional Features:

- Tubular steel frame finished in Polished Chrome
- Seat to seat linking
- Two-tone upholstery
- Felt glides

Frame Finishes:



For larger swatches go to pg.188-205

Pause - PSM102 Single seat unit with a full back

Standard Features:

- Traditional carcass construction
- Molded foam back construction
- Tubular steel frame finished in Silver M04 powder coat
- Plastic glides with leveling adjustment

Optional Features:

- Tubular steel frame finished in Polished Chrome
- Seat to seat linking
- Two-tone upholstery
- Felt glides

Frame Finishes:



For larger swatches go to pg.188-205

Pause - PSM202 Two seat unit with two backrests

Standard Features:

- Traditional carcass construction
- Molded foam back construction
- Tubular steel frame finished in Silver M04 powder coat
- Plastic glides with leveling adjustment

Optional Features:

- Tubular steel frame finished in Polished Chrome
- Seat to seat linking
- Two-tone upholstery
- Felt glides

Frame Finishes:

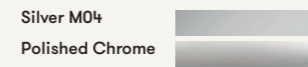

For larger swatches go to pg.188-205

Pause

Design by Allermuir Design Studio

PSM100 OH: 17.75" OW: 29.5" OD: 29.5"	PSM101RH OH: 30.75" OW: 29.5" OD: 29.5"	PSM101LH OH: 30.75" OW: 29.5" OD: 29.5"	PSM102 OH: 30.75" OW: 29.5" OD: 29.5"
PSM103RH OH: 30.75" OW: 29.5" OD: 29.5"	PSM103LH OH: 30.75" OW: 29.5" OD: 29.5"	PSM200 OH: 17.75" OW: 59" OD: 29.5"	PSM201RH OH: 30.75" OW: 59" OD: 29.5"
PSM201LH OH: 30.75" OW: 59" OD: 29.5"	PSM202 OH: 30.75" OW: 59" OD: 29.5"	PSM203RH OH: 30.75" OW: 59" OD: 29.5"	PSM203LH OH: 30.75" OW: 59" OD: 29.5"
PSM204 OH: 30.75" OW: 59" OD: 29.5"	PSM205 OH: 30.75" OW: 59" OD: 29.5"	PSM206(RH) OH: 30.75" OW: 59" OD: 29.5"	PSM207(LH) OH: 30.75" OW: 59" OD: 29.5"
PSP075H OH: 23.5" OW: 9.75" OD: 29.5"	PSP075L OH: 17.75" OW: 9.75" OD: 29.5"	PSS042H OH: 30.75" OW: 16.5" OD: 16.5"	PSS042L OH: 19" OW: 16.5" OD: 16.5"

↓ Scan here to discover more



Pause

Design by Allermuir Design Studio

86

87

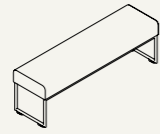
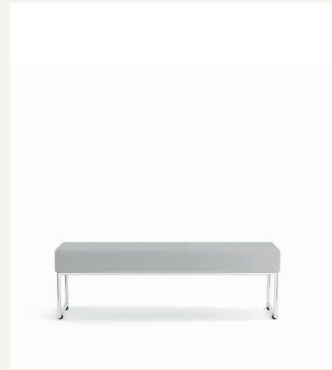

PSB154L - Low bench
OH: 19"
OW: 59"
OD: 16.5"

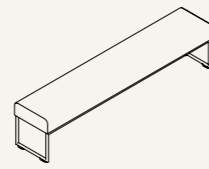

PSB214L - Low bench
OH: 19"
OW: 82.75"
OD: 16.5"

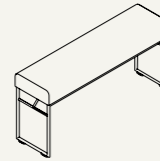

PSB154H - High bench
OH: 28.5"
OW: 59"
OD: 16.5"

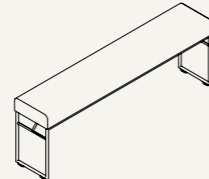

PSB214H - High bench
OH: 28.5"
OW: 82.75"
OD: 16.5"

Pause - PSB154L Low bench 82.75w

Standard Features:

- Traditional carcass construction
- Tubular steel frame finished in Silver M04 powder coat
- Plastic glides with leveling adjustment

Optional Features:

- Tubular steel frame available in Polished Chrome
- Two-tone upholstery
- Felt Guides

Frame Finishes:

Silver M04



Polished Chrome

For larger swatches go to pg.188-205

Pebble

Design by Allermuir Design Studio

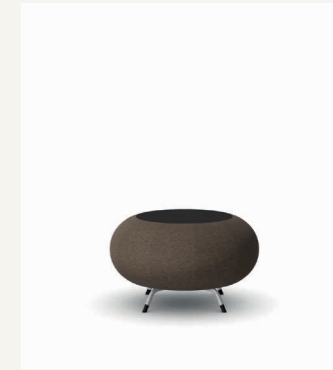
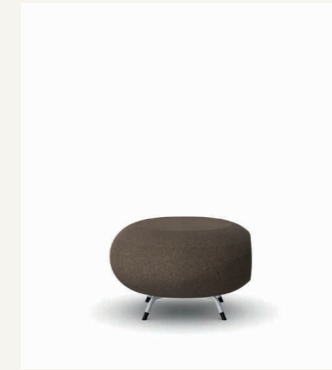
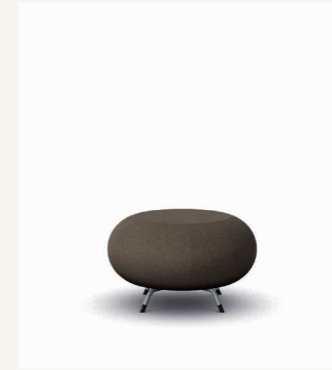

Pebble - A620 Stool

Dimensions:

Overall Height 17"
Diameter 28.75"

Standard Features:

- Molded foam construction
- Webbed seat support
- Fully upholstered
- Tubular Steel leg finished in Silver powder coat
- Plastic glides

Optional Features:

- Linking bracket
- Two-tone upholstery
- Decorative Railroad Stitch Detail in Black, White, Red, Light Gray, Dark Gray or Cream

Frame Finish:

Silver



For larger swatches go to pg.188-205

Pebble - A621 Scalloped Stool

Dimensions:

Overall Height 17"
Diameter 28.75"

Standard Features:

- Molded foam construction
- Webbed seat support
- Fully upholstered
- Tubular Steel leg finished in Silver powder coat
- Plastic glides

Optional Features:

- Linking bracket
- Two-tone upholstery
- Decorative Railroad Stitch Detail in Black, White, Red, Light Gray, Dark Gray or Cream

Frame Finish:

Silver



For larger swatches go to pg.188-205

Pebble - A622 Table topped unit

Dimensions:

Overall Height 17"
Diameter 28.75"

Standard Features:

- Molded foam construction
- Laminate table top
- Tubular Steel leg finished in Silver powder coat
- Plastic glides

Optional Features:

- Linking bracket
- Decorative Railroad Stitch Detail in Black, White, Red, Light Gray, Dark Gray or Cream

Frame Finish:

Silver



For larger swatches go to pg.188-205

16 optional Global Laminates are also available please go to pg. 196 to see more.

↓ Scan here to discover more



↓ Scan here to discover more

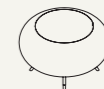

Plum

Design By Mark Gabbertas

88

89

Plum

Design By Mark Gabbertas



Plum - PLM01 Lounge Chair

Dimensions:

Seat Height	17.5"
Seat Width	20.75"
Seat Depth	19.25"
Overall Height	30.5"
Overall Width	23.5"
Overall Depth	26"

Standard Features:

- Molded foam construction
- Tubular Steel frame finished in Black powder coat
- Plastic glides

Optional Features:

- Plastic glides with felt

Frame Finish:

Black

For larger swatches go to pg.188-205

Plum - PLM02 Lounge Chair with Arms

Dimensions:

Seat Height	17.5"
Seat Width	20.75"
Seat Depth	19.25"
Overall Height	30.5"
Overall Width	28.25"
Overall Depth	26"

Standard Features:

- Molded foam construction
- Molded foam arms
- Tubular Steel frame finished in Black powder coat
- Plastic glides

Optional Features:

- Plastic glides with felt

Frame Finish:

Black

For larger swatches go to pg.188-205

Plum - PLM100 1 Seat Sofa

Dimensions:

Seat Height	18"
Seat Width	33.25"
Seat Depth	22.75"
Overall Height	33.75"
Overall Width	36.25"
Overall Depth	29.5"

Standard Features:

- Molded foam construction
- Molded foam arms
- Fully Upholstered
- Tubular Steel back frame with foam overmold and tensioned fabric
- Tubular Steel frame finished in Black powder coat
- Plastic glides

Optional Features:

- Plastic glides with felt
- Two-tone Upholstery

Frame Finish:

Black

For larger swatches go to pg.188-205

Plum - PLM200 2 Seat Sofa

Dimensions:

Seat Height	18"
Seat Width	62.75"
Seat Depth	22.75"
Overall Height	33.75"
Overall Width	65.75"
Overall Depth	29.5"

Standard Features:

- Molded foam construction
- Molded foam arms
- Fully Upholstered
- Tubular Steel back frame with foam overmold and tensioned fabric
- Tubular Steel frame finished in Black powder coat
- Plastic glides

Optional Features:

- Plastic glides with felt
- Two-tone Upholstery

Frame Finish:

Black

For larger swatches go to pg.188-205

Plum - PLM300 3 Seat Sofa

Dimensions:

Seat Height	18"
Seat Width	90.25"
Seat Depth	22.75"
Overall Height	33.75"
Overall Width	93.25"
Overall Depth	29.5"

Standard Features:

- Molded foam construction
- Molded foam arms
- Fully Upholstered
- Tubular Steel back frame with foam overmold and tensioned fabric
- Tubular Steel frame finished in Black powder coat
- Plastic glides

Optional Features:

- Plastic glides with felt
- Two-tone Upholstery

Frame Finish:

Black

For larger swatches go to pg.188-205

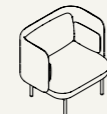

↓ Scan here to discover more



↓ Scan here to discover more

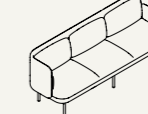

Plum Collection

Design By Mark Gabbertas

90

91

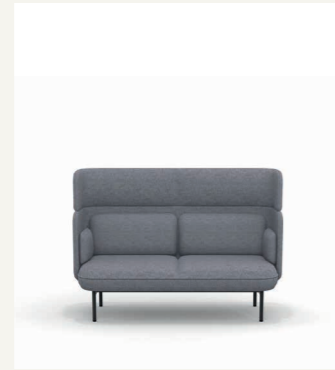
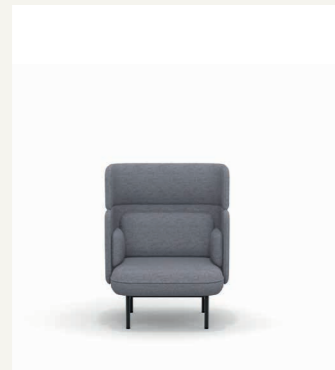

Plum - PLM100HR
1 Seat Sofa with Headrest

Dimensions:

Seat Height	18"
Seat Width	33.25"
Seat Depth	22.75"
Overall Height	46.25"
Overall Width	36.25"
Overall Depth	29.5"

Standard Features:

- Molded foam construction
- Molded foam arms
- Fully Upholstered
- Tubular Steel back frame with foam overmold and tensioned fabric
- Tubular Steel frame finished in Black powder coat
- Plastic glides

Optional Features:

- Plastic glides with felt
- Two-tone Upholstery

Frame Finish:

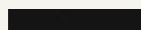
Black 

For larger swatches go to pg.188-205

Plum - PLM200HR
2 Seat Sofa with Headrest

Dimensions:

Seat Height	18"
Seat Width	62.75"
Seat Depth	22.75"
Overall Height	46.25"
Overall Width	65.75"
Overall Depth	29.5"

Standard Features:

- Molded foam construction
- Molded foam arms
- Fully Upholstered
- Tubular Steel back frame with foam overmold and tensioned fabric
- Tubular Steel frame finished in Black powder coat
- Plastic glides

Optional Features:

- Plastic glides with felt
- Two-tone Upholstery

Frame Finish:

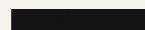
Black 

For larger swatches go to pg.188-205

Plum - PLM300HR
3 Seat Sofa with Headrest

Dimensions:

Seat Height	18"
Seat Width	90.25"
Seat Depth	22.75"
Overall Height	46.25"
Overall Width	93.25"
Overall Depth	29.5"

Standard Features:

- Molded foam construction
- Molded foam arms
- Fully Upholstered
- Tubular Steel back frame with foam overmold and tensioned fabric
- Tubular Steel frame finished in Black powder coat
- Plastic glides

Optional Features:

- Plastic glides with felt
- Two-tone Upholstery

Frame Finish:

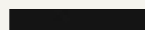
Black 

For larger swatches go to pg.188-205

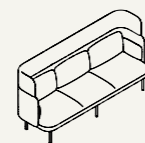
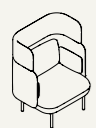

↓ Scan here to discover more



↓ Scan here to discover more



Plum

Design By Mark Gabbertas

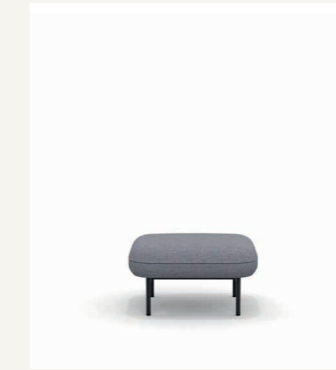

Pebble - PLM101
1 Seat Ottoman

Dimensions:

Seat Height	18"
Seat Width	33.25"
Seat Depth	28"

Standard Features:

- Molded foam construction
- Fully Upholstered
- Tubular Steel frame finished in Black powder coat
- Plastic glides

Optional Features:

- Plastic glides with felt

Frame Finish:

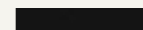
Black 

For larger swatches go to pg.188-205

Pebble - PLM201
2 Seat Ottoman

Dimensions:

Seat Height	18"
Seat Width	62.75"
Seat Depth	28"

Standard Features:

- Molded foam construction
- Fully Upholstered
- Tubular Steel frame finished in Black powder coat
- Plastic glides

Optional Features:

- Plastic glides with felt

Frame Finish:

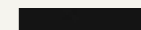
Black 

For larger swatches go to pg.188-205

Pebble - PLM301
3 Seat Ottoman

Dimensions:

Seat Height	18"
Seat Width	90.25"
Seat Depth	28"

Standard Features:

- Molded foam construction
- Fully Upholstered
- Tubular Steel frame finished in Black powder coat
- Plastic glides

Optional Features:

- Plastic glides with felt

Frame Finish:

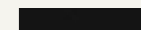
Black 

For larger swatches go to pg.188-205

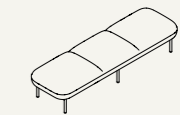

Qu

Design By Allermuir Design Studio

92

93



Qu - CUB02 Fully Upholstered Stool

Dimensions:

Overall Height 18"
Overall Width 19.75"
Overall Depth 19.75"

Standard Features:

- Traditional carcass construction
- Deep quilted upholstery
- Plastic glides

Optional Features:

- Two-tone upholstery

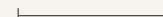
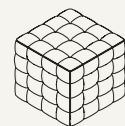

Tarry

Design By Wolfgang C. R. Mezger



Tarry - TAR403 Wing lounge chair with wood legs

Dimensions:

Seat Height 17"
Seat Width 21.5"
Seat Depth 20.5"
Overall Height 48.25"
Overall Width 29.25"
Overall Depth 32"

Standard Features:

- Molded foam construction with dual density back foam
- Height adjustable headrest
- Fully upholstered
- Solid Ash legs with a clear finish
- Plastic glides

Optional Features:

- Solid Ash legs can be stained or color washed
- Plastic glides with felt
- Two-tone upholstery

Wood Stains based on Ash:

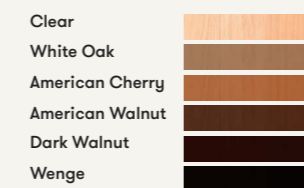

For larger swatches go to pg.188-205

16 optional standard color washes based on Ash are also available please go to pg. 194 to see more.

↓ Scan here to discover more



↓ Scan here to discover more



Tarry - TAR404 Wing chair on a 4 star swivel base

Dimensions:

Seat Height 18"
Seat Width 21.5"
Seat Depth 20.5"
Overall Height 49.5"
Overall Width 34"
Overall Depth 34"

Standard Features:

- Molded foam construction with dual density back foam
- Height adjustable headrest
- Free floating seat tilt with upright locking
- Fully upholstered
- 4 star Aluminum auto return swivel blade base finished in New Black powder coat
- Plastic glides

Optional Features:

- 4 Star auto return swivel base available in Polished Aluminum and a selection of powder coat finishes
- Two-tone upholstery

Frame Finishes:

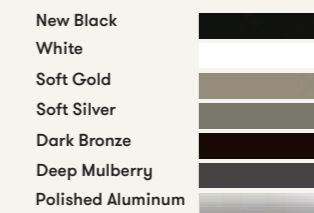

For larger swatches go to pg.188-205

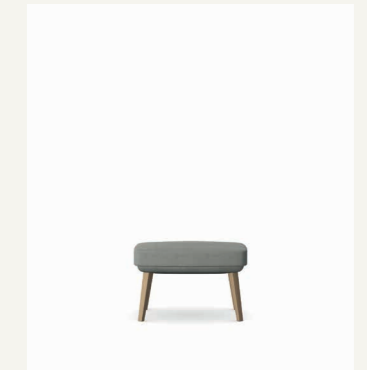

Tarry - TARFS03 Footstool with wood legs

Dimensions:

Overall Height 16.25"
Overall Width 24.25"
Overall Depth 18.25"

Standard Features:

- Fully upholstered
- Solid Ash legs with a clear finish
- Plastic glides

Optional Features:

- Solid Ash legs can be stained or color washed
- Plastic glides with felt
- Two-tone upholstery

Wood Stains based on Ash:



For larger swatches go to pg.188-205

16 optional standard color washes based on Ash are also available please go to pg. 194 to see more.



Tylus

Design By Allermuir Design Studio

94



Tylus - TYL16H Soft square cushion with grab handle

Standard Features:

- Curled feather filled cushion with fire retardant inner cover
- Lines, Aztec, Echo or Flow Quilt detail options available
- Saddle leather grab handle available in Black, Natural or Dark Tan on select models
- Zipper available in Gold, Rose Gold, Silver or Black

For Quilting and Finish swatches go to pg. 200



TYL2010 - Soft rectangle
OH: 10"
OW: 20"

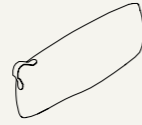

TYL2010H - Soft rectangle
OH: 10"
OW: 20"



TYL16 - Soft square
OH: 16"
OW: 16"



TYL16H - Soft square with grab handle
OH: 16"
OW: 16"



TYL20 - Soft square
OH: 20"
OW: 20"

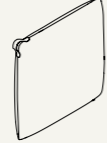

TYL20H - Soft square with grab handle
OH: 20"
OW: 20"



TYL24 - Soft square
OH: 24"
OW: 24"



TYL24H - Soft square with grab handle
OH: 24"
OW: 24"

95

Cushions

Design By Allermuir Design Studio



Loose Cushion - AMSCS Small square cushion

Standard Features:

- Fire retardant inner cushion cover
- Soft fill stuffing
- Twinned edge stitching detail
- Panelled sides available on AMSCRD only

Optional Features:

- Two-tone upholstery
- Twinned edge detail (TW) a twin needle stitch detail around perimeter, with zip to one side
- Piped edge detail (PP) piping detail around perimeter, with zip to one side.
- Added option of two-tone color on piped detail edge only
- Zipped edge detail (ZL) reverse zip detail around whole perimeter
- Plain face detail (PL)
- Single button face detail (SB)
- Multi button face detail (MB)
- Quilted face detail (QU)

*Add the two letter prefix for the Edge Detail and Face Detail to your cushion code when ordering

For all Cushion Edge and Face Details go to pg.202



AMSCS - Small square
OH: 15.75"
OW: 15.75"



AMSCM - Medium square
OH: 19"
OW: 19"



AMSCS - Large square
OH: 22"
OW: 22"

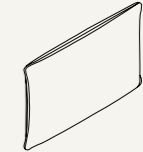

AMSCBL - Bolster cushion
OH: 13.75"
OW: 22"



AMSCRD - Round cushion
D: 13.75"

↓ Scan here to discover more



↓ Scan here to discover more



Contents

100	Grainger
101	Haven Bench
103	Mayze
104	Mozaik
106	Pause
108	Paver
108	Pebble
111	Plum
112	Qu
113	Stirling

Grainger

Design by Allermuir Design Studio

100

101

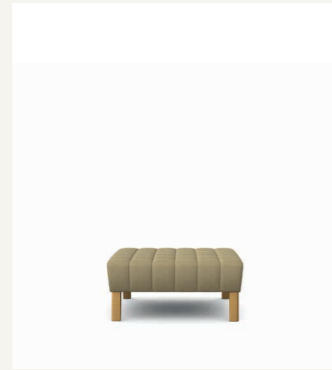
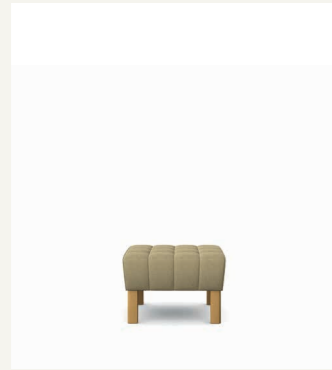

Grainger - GR7
Small ottoman

Dimensions:
Overall Height 15.25"
Overall Width 24"
Overall Depth 24"

- Standard Features:
- Traditional carcass construction
 - Webbed seat support
 - Solid Oak legs with a clear finish

- Optional Features:
- Solid Oak legs can be stained or color washed
 - Two-tone upholstery

Wood Stains based on Oak:



For larger swatches go to pg.188-205

16 optional standard color washes based on Oak are also available please go to pg.194 to see more.

Grainger - GR8
Large ottoman

Dimensions:
Overall Height 15.25"
Overall Width 34"
Overall Depth 34"

- Standard Features:
- Traditional carcass construction
 - Webbed seat support
 - Solid Oak legs with a clear finish

- Optional Features:
- Solid Oak legs can be stained or color washed
 - Two-tone upholstery

Wood Stains based on Oak:



For larger swatches go to pg.188-205

16 optional standard color washes based on Oak are also available please go to pg.194 to see more.

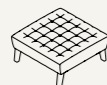

Haven Bench

Design By Mark Gabbertas

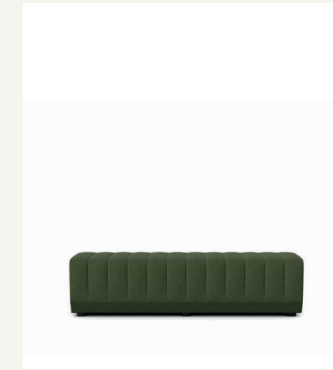
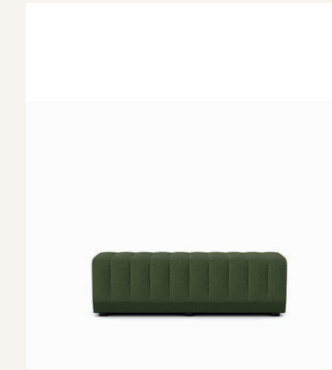
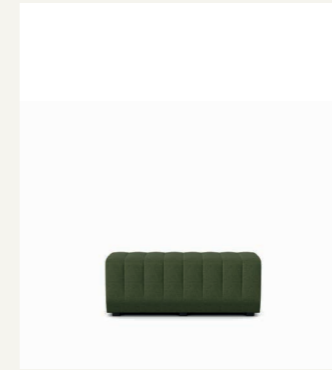

Haven Bench - HAB100
47" Bench with no linking connectors

Dimensions:
Overall Height 17.75"
Overall Width 47.25"
Overall Depth 21.75"

- Standard Features:
- Traditional carcass construction
 - Fully upholstered bench with quilted detail
 - Plastic glides

- Optional Features:
- Plastic glides with felt
 - Bench with linking connectors on both ends also available: HAB100M
 - Bench with linking connectors on one end also available: HAB100E

Haven Bench - HAB200
59" Bench with no linking connectors

Dimensions:
Overall Height 17.75"
Overall Width 59"
Overall Depth 21.75"

- Standard Features:
- Traditional carcass construction
 - Fully upholstered bench with quilted detail
 - Plastic glides

- Optional Features:
- Plastic glides with felt
 - Bench with linking connectors on both ends also available: HAB200M
 - Bench with linking connectors on one end also available: HAB200E

Haven Bench - HAB300
71" Bench with no linking connectors

Dimensions:
Overall Height 17.75"
Overall Width 71"
Overall Depth 21.75"

- Standard Features:
- Traditional carcass construction
 - Fully upholstered bench with quilted detail
 - Plastic glides

- Optional Features:
- Plastic glides with felt
 - Bench with linking connectors on both ends also available: HAB300M
 - Bench with linking connectors on one end also available: HAB300E

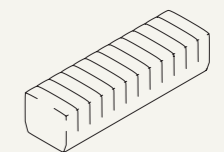
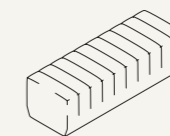
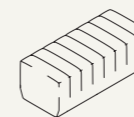

↓ Scan here to discover more



↓ Scan here to discover more



Haven Bench

Design By Mark Gabbertas

102

103

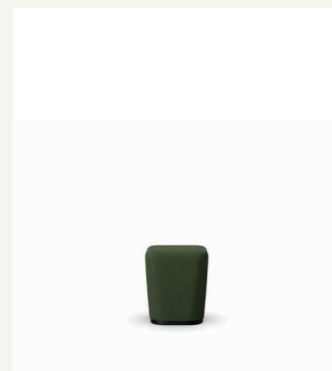
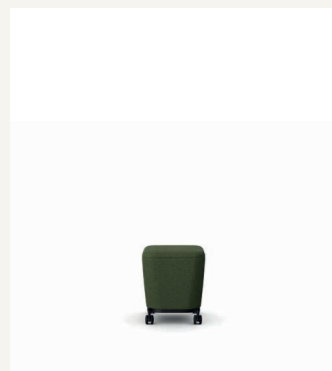

Haven Bench - HAS040LC Mobile Low Stool

Dimensions:

Overall Height 19"
Overall Width 15.75"
Overall Depth 15.75"

Standard Features:

- Traditional carcass construction
- Fully upholstered bench
- Steel frame finished in Black (Textured) powder coat
- Black casters

Optional Features:

- Two-tone upholstery

Frame Finish:

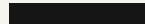
Black (Textured) 

For larger swatches go to pg.188-205

Haven Bench - HAS040L Static Stool

Dimensions:

Overall Height 19"
Overall Width 15.75"
Overall Depth 15.75"

Standard Features:

- Traditional carcass construction
- Fully upholstered bench
- Plastic glides
- Steel frame finished in Black (Textured) powder coat

Optional Features:

- Two-tone upholstery

Frame Finish:

Black (Textured) 

For larger swatches go to pg.188-205



↓ Scan here to
discover more



↓ Scan here to
discover more



Mayze

Design by Allermuir Design Studio

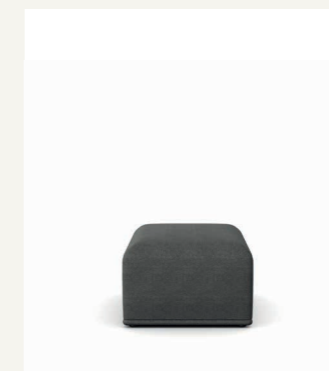

Mayze - MZE01 Ottoman

Dimensions:

Overall Height 15.25"
Overall Width 26.5"
Overall Depth 34.5"

Standard Features:

- Traditional carcass construction
- Tensioned seat support
- Seat to seat linking
- Felt glides

Optional Features:

- Two-Tone Upholstery

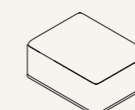

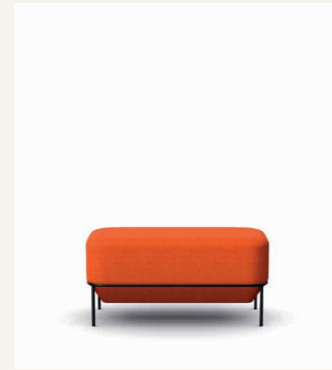
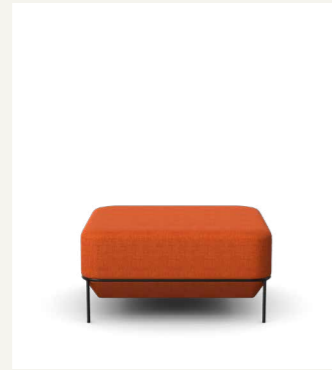
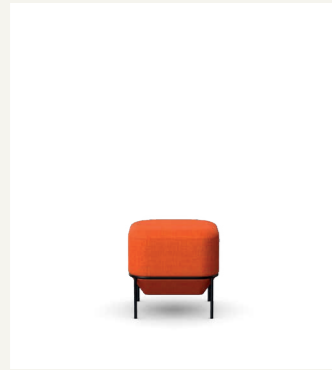

Mozaik - MZK101
Low square stool, small

Dimensions:
Overall Height 16.5"
Overall Width 17.25"
Overall Depth 17.25"

- Standard Features:
- Traditional carcass construction
 - Fully upholstered
 - Wire frame finished in Black powder coat
 - Plastic glides

- Optional Features:
- Wire frame available in a White powder coat finish
 - Two tone upholstery

Frame Finishes



For larger swatches go to pg.188-205

Mozaik - MZK102
Large low square stool

Dimensions:
Overall Height 16.5"
Overall Width 34"
Overall Depth 34"

- Standard Features:
- Traditional carcass construction
 - Fully upholstered
 - Wire frame finished in Black powder coat
 - Plastic glides

- Optional Features:
- Wire frame available in a White powder coat finish
 - Two tone upholstery

Frame Finishes



For larger swatches go to pg.188-205

Mozaik - MZK103
Low rectangular bench

Dimensions:
Overall Height 16.5"
Overall Width 17.25"
Overall Depth 34"

- Standard Features:
- Traditional carcass construction
 - Fully upholstered
 - Wire frame finished in Black powder coat
 - Plastic glides

- Optional Features:
- Wire frame available in a White powder coat finish
 - Two tone upholstery

Frame Finishes



For larger swatches go to pg.188-205

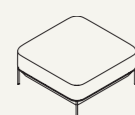

↓ Scan here to discover more



↓ Scan here to discover more

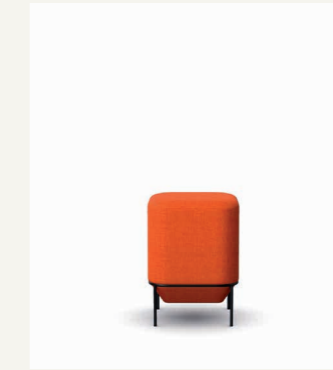

Mozaik - MZK201
Small high square stool

Dimensions:
Overall Height 23.5"
Overall Width 17.25"
Overall Depth 17.25"

- Standard Features:
- Traditional carcass construction
 - Fully upholstered
 - Wire frame finished in Black powder coat
 - Plastic glides

- Optional Features:
- Wire frame available in a White powder coat finish
 - Two tone upholstery

Frame Finishes



For larger swatches go to pg.188-205

Mozaik - MZK203
High rectangular bench

Dimensions:
Overall Height 23.5"
Overall Width 17.25"
Overall Depth 34"

- Standard Features:
- Traditional carcass construction
 - Fully upholstered
 - Wire frame finished in Black powder coat
 - Plastic glides

- Optional Features:
- Wire frame available in a White powder coat finish
 - Two tone upholstery

Frame Finishes

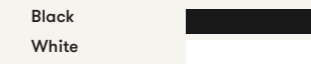

For larger swatches go to pg.188-205



Pause

Design by Allermuir Design Studio

106

107

Pause

Design by Allermuir Design Studio

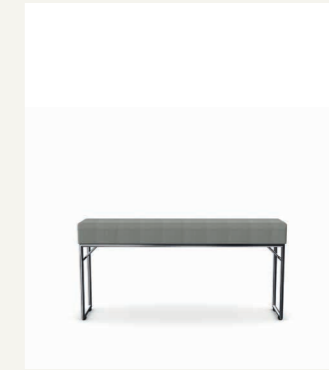
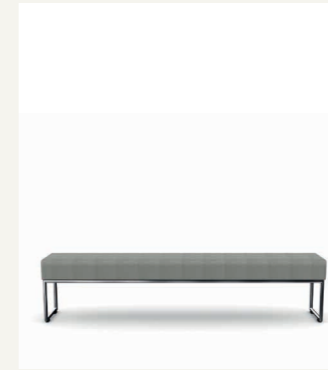
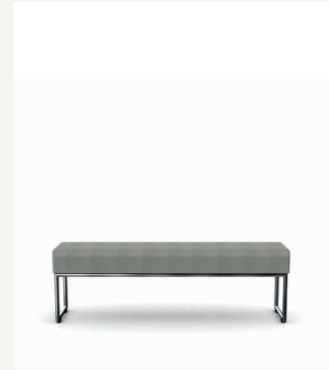
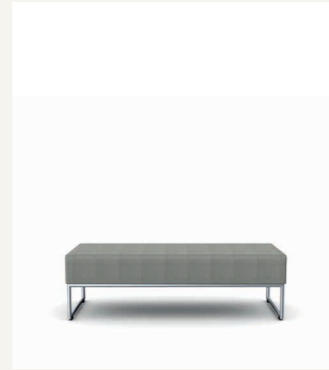
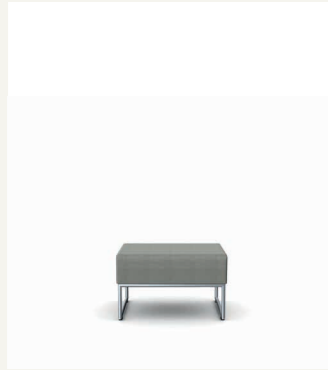

Pause - PSM100 Single seat unit

Dimensions:

Overall Height 17.75"
Overall Width 29.5"
Overall Depth 29.5"

Standard Features:

- Traditional carcass construction
- Tubular steel frame finished in Silver M04 powder coat
- Plastic glides with leveling adjustment

Optional Features:

- Tubular steel frame available in Polished Chrome
- Seat to seat linking
- Two-tone upholstery
- Felt Guides

Frame Finishes:

Silver M04 
Polished Chrome 

For larger swatches go to pg.188-205

Pause - PSM200 Two seat unit

Dimensions:

Overall Height 17.75"
Overall Width 59"
Overall Depth 29.5"

Standard Features:

- Traditional carcass construction
- Tubular steel frame finished in Silver M04 powder coat
- Plastic glides with leveling adjustment

Optional Features:

- Tubular steel frame available in Polished Chrome
- Seat to seat linking
- Two-tone upholstery
- Felt Guides

Frame Finishes:

Silver M04 
Polished Chrome 

For larger swatches go to pg.188-205

Pause - PSB154L 59 inch w Low bench

Dimensions:

Overall Height 19"
Overall Width 59"
Overall Depth 16.5"



Standard Features:

- Traditional carcass construction
- Tubular steel frame finished in Silver M04 powder coat
- Plastic glides with leveling adjustment

Optional Features:

- Tubular steel frame available in Polished Chrome
- Two-tone upholstery
- Felt Guides

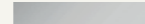
Frame Finishes:

Silver M04 
Polished Chrome 

For larger swatches go to pg.188-205

Pause - PSB214L 82.5 inch w Low bench

Dimensions:

Overall Height 19"
Overall Width 82.75"
Overall Depth 16.5"

Standard Features:

- Traditional carcass construction
- Tubular steel frame finished in Silver M04 powder coat
- Plastic glides with leveling adjustment

Optional Features:

- Tubular steel frame available in Polished Chrome
- Two-tone upholstery
- Felt Guides

Frame Finishes:

Silver M04 
Polished Chrome 

For larger swatches go to pg.188-205

Pause - PSB154H 59 inch w High bench

Dimensions:

Overall Height 28.5"
Overall Width 59"
Overall Depth 16.5"



Standard Features:

- Traditional carcass construction
- Tubular steel frame finished in Silver M04 powder coat
- Plastic glides with leveling adjustment

Optional Features:

- Tubular steel frame available in Polished Chrome
- Two-tone upholstery
- Felt Guides

Frame Finishes:

Silver M04 
Polished Chrome 

For larger swatches go to pg.188-205

Pause - PSB214H 82.5 inch w High bench

Dimensions:

Overall Height 28.5"
Overall Width 82.75"
Overall Depth 16.5"



Standard Features:

- Traditional carcass construction
- Tubular steel frame finished in Silver M04 powder coat
- Plastic glides with leveling adjustment

Optional Features:

- Tubular steel frame available in Polished Chrome
- Two-tone upholstery
- Felt Guides

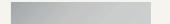
Frame Finishes:

Silver M04 
Polished Chrome 

For larger swatches go to pg.188-205

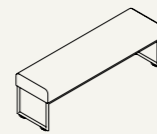
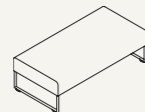
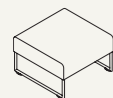

↓ Scan here to discover more



↓ Scan here to discover more

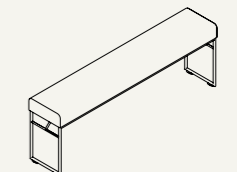
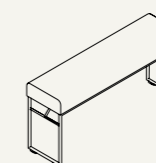
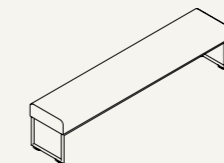



Paver - PVRS25SQ Square Seat

Dimensions:

Overall Height 15"
Overall Width 25.5"
Overall Depth 25.5"

Standard Features:

- Traditional carcass construction
- Super soft foam upholstery
- Turned out top sewn seam
- Configurable linking plates x 2
- Plastic glides

Optional Features:

- Two-tone upholstery

Paver - PVRS38SQ Square Seat

Dimensions:

Overall Height 15"
Overall Width 38.5"
Overall Depth 38.5"

Standard Features:

- Traditional carcass construction
- Super soft foam upholstery
- Turned out top sewn seam
- Configurable linking plates x 2
- Plastic glides

Optional Features:

- Two-tone upholstery

Paver - PVRS51SQ Square Seat

Dimensions:

Overall Height 15"
Overall Width 51.25"
Overall Depth 51.25"

Standard Features:

- Traditional carcass construction
- Super soft foam upholstery
- Turned out top sewn seam
- Configurable linking plates x 2
- Plastic glides

Optional Features:

- Two-tone upholstery



Paver - PVRS38 Rectangular Seat

Dimensions:

Overall Height 15"
Overall Width 38.5"
Overall Depth 25.5"

Standard Features:

- Traditional carcass construction
- Super soft foam upholstery
- Turned out top sewn seam
- Configurable linking plates x 2
- Plastic glides

Optional Features:

- Two-tone upholstery

Paver - PVRS51 Rectangular Seat

Dimensions:

Overall Height 15"
Overall Width 51.25"
Overall Depth 25.5"

Standard Features:

- Traditional carcass construction
- Super soft foam upholstery
- Turned out top sewn seam
- Configurable linking plates x 2
- Plastic glides

Optional Features:

- Two-tone upholstery

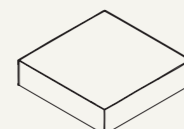
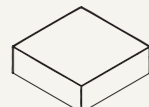
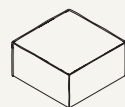

↓ Scan here to discover more



↓ Scan here to discover more

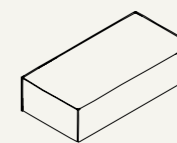
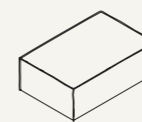

Pebble

Design By Allermuir Design Studio

110

111

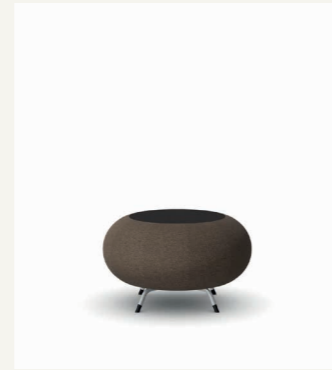
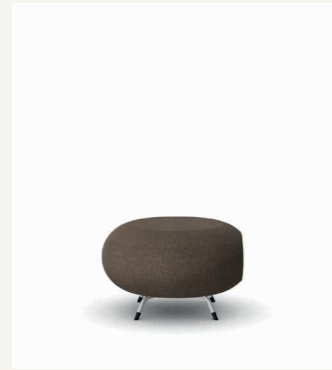
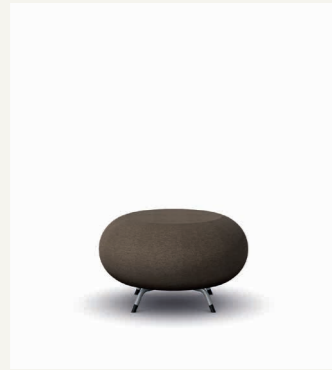

Pebble - A620
Stool

Dimensions:
Overall Height 17"
Diameter 28.75"

- Standard Features:
- Molded foam construction
 - Webbed seat support
 - Fully upholstered
 - Tubular Steel leg finished in Silver powder coat
 - Plastic glides

- Optional Features:
- Linking bracket
 - Two-tone upholstery
 - Decorative Railroad Stitch Detail in Black, White, Red, Light Gray, Dark Gray or Cream

Frame Finish:
Silver

For larger swatches go to pg.188-205

Pebble - A621
Scalloped Stool

Dimensions:
Overall Height 17"
Diameter 28.75"

- Standard Features:
- Molded foam construction
 - Webbed seat support
 - Fully upholstered
 - Tubular Steel leg finished in Silver powder coat
 - Plastic glides

- Optional Features:
- Linking bracket
 - Two-tone upholstery
 - Decorative Railroad Stitch Detail in Black, White, Red, Light Gray, Dark Gray or Cream

Frame Finish:
Silver

For larger swatches go to pg.188-205

Pebble - A622
Table topped unit

Dimensions:
Overall Height 17"
Diameter 28.75"

- Standard Features:
- Molded foam construction
 - Laminate table top
 - Tubular Steel leg finished in Silver powder coat
 - Plastic glides

- Optional Features:
- Linking bracket
 - Decorative Railroad Stitch Detail in Black, White, Red, Light Gray, Dark Gray or Cream

Frame Finish:
Silver

For larger swatches go to pg.188-205

16 optional Global Laminates are also available please go to pg. 196 to see more.



↓ Scan here to discover more



↓ Scan here to discover more



Plum

Design By Mark Gabbertas

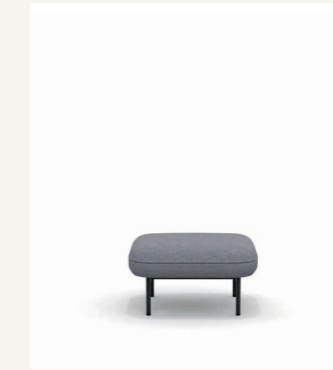

Pebble - PLM101
1 Seat Ottoman

Dimensions:
Seat Height 18"
Seat Width 33.25"
Seat Depth 28"

- Standard Features:
- Molded foam construction
 - Fully Upholstered
 - Tubular Steel frame finished in Black powder coat
 - Plastic glides

- Optional Features:
- Plastic glides with felt

Frame Finish:
Black

For larger swatches go to pg.188-205

Pebble - PLM201
2 Seat Ottoman

Dimensions:
Seat Height 18"
Seat Width 62.75"
Seat Depth 28"

- Standard Features:
- Molded foam construction
 - Fully Upholstered
 - Tubular Steel frame finished in Black powder coat
 - Plastic glides

- Optional Features:
- Plastic glides with felt

Frame Finish:
Black

For larger swatches go to pg.188-205

Pebble - PLM301
3 Seat Ottoman

Dimensions:
Seat Height 18"
Seat Width 90.25"
Seat Depth 28"

- Standard Features:
- Molded foam construction
 - Fully Upholstered
 - Tubular Steel frame finished in Black powder coat
 - Plastic glides

- Optional Features:
- Plastic glides with felt

Frame Finish:
Black

For larger swatches go to pg.188-205

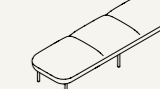

Qu

Design By Allermuir Design Studio

112

113



Qu - CUB02 Fully Upholstered Stool

Dimensions:
Overall Height 18"
Overall Width 19.75"
Overall Depth 19.75"

- Standard Features:
- Traditional carcass construction
 - Deep quilted upholstery
 - Plastic glides

- Optional Features:
- Two-tone upholstery

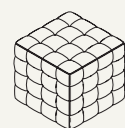

Stirling

Design by Allermuir Design Studio

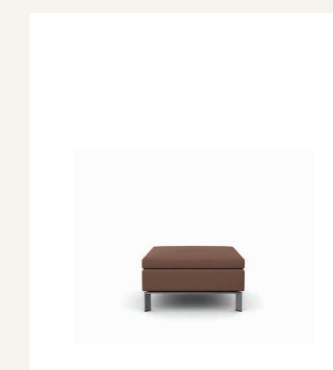

Stirling - SLB01 Single seat bench unit

Dimensions:
Overall Height 17.75"
Overall Width 29.5"
Overall Depth 29.5"

- Standard Features:
- Traditional carcass construction
 - Coil sprung seat support
 - Flat steel frame finished in Brushed Chrome
 - Plastic glides

Frame Finish:

Brushed Chrome

For larger swatches go to pg.188-205

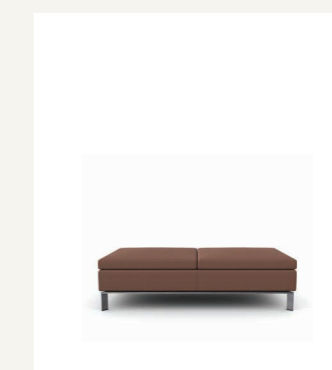

Stirling - SLB02 Two seat bench unit

Dimensions:
Overall Height 17.75"
Overall Width 59"
Overall Depth 29.5"

- Standard Features:
- Traditional carcass construction
 - Coil sprung seat support
 - Flat steel frame finished in Brushed Chrome
 - Plastic glides

Frame Finish:

Brushed Chrome

For larger swatches go to pg.188-205

↓ Scan here to discover more



↓ Scan here to discover more

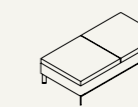

Contents

116	Mayze
118	Obris
119	Orai
120	Oran
122	Paver
124	Plum
128	Stirling

114

115

Sofas

Mayze

Design by Allermuir Design Studio

116

117

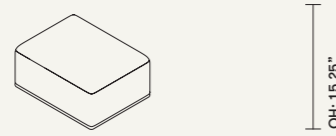

OH: 15.25"

MZE01 - Ottoman
SH: 15.25"
SW: 26.5"
SD: 34.5"
OW: 26.5"
OD: 34.5"

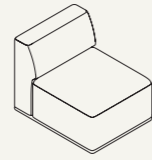

OH: 27.75"

MZE02 - Single Seat
SH: 15.25"
SW: 26.5"
SD: 26.5"
OW: 26.5"
OD: 34.5"

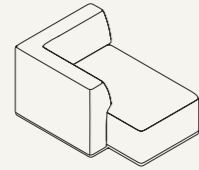

OH: 27.75"

MZE04 - Chaise Seat (Right hand)
SH: 15.25"
SW: 26.5"
SD: 41.25"
OW: 34.5"
OD: 49.25"

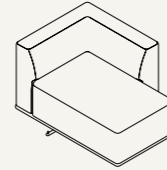

OH: 27.75"

MZE05 - Chaise Seat (Left hand)
SH: 15.25"
SW: 26.5"
SD: 41.25"
OW: 34.5"
OD: 49.25"

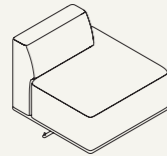

OH: 27.75"

MZE06 - End Module Seat (Right hand)
SH: 15.25"
SW: 26.5"
SD: 26.5"
OW: 26.5"
OD: 34.5"

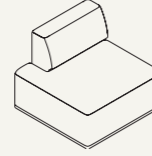

OH: 27.75"

MZE07 - End Module Seat (Left hand)
SH: 15.25"
SW: 26.5"
SD: 26.5"
OW: 26.5"
OD: 34.5"

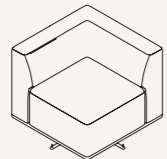

OH: 27.75"

MZE08 - Corner Seat (Right hand)
SH: 15.25"
SW: 26.5"
SD: 26.5"
OW: 34.5"
OD: 34.5"

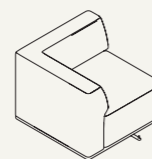

OH: 27.75"

MZE09 - Corner Seat (Left hand)
SH: 15.25"
SW: 26.5"
SD: 26.5"
OW: 34.5"
OD: 34.5"

Mayze

Standard Features:

- Traditional carcass construction
- Tensioned seat support
- Seat to seat linking
- Felt glides

Optional Features:

- Two-Tone Upholstery

Configurations:

Create your own using our product configurator at allermuir.com

1. MZE04
MZE02 x 3
MZE09
MZE06

1

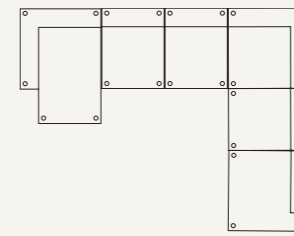

2

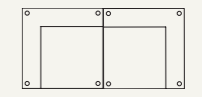

2. MZE08
MZE09

3. MZE07 x 2
MZE02 x 5
MZE08
MZE06

3

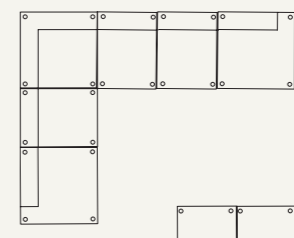

4

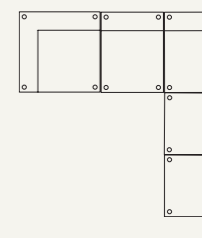

4. MZE08
MZE02 x 2
MZE09
MZE01

5. MZE07
MZE02 x 7
MZE08
MZE09
MZE06

5

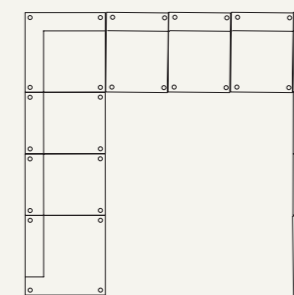

6

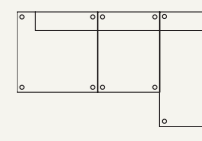

6. MZE07
MZE02
MZE05

7. MZE08
MZE09
MZE02 x 5
MZE05

7

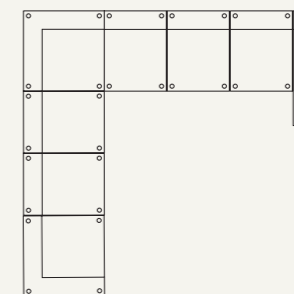

8

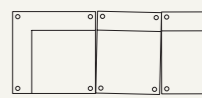

6. MZE08
MZE02
MZE09

↓ Scan here to discover more



Obris

Design by Jonas Wagell

118

119

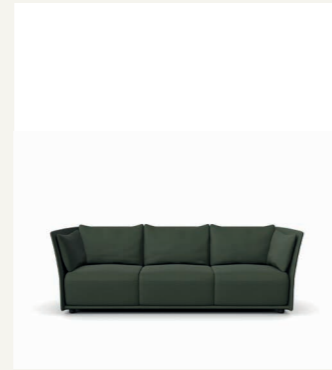
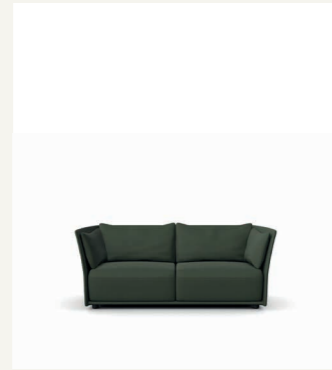
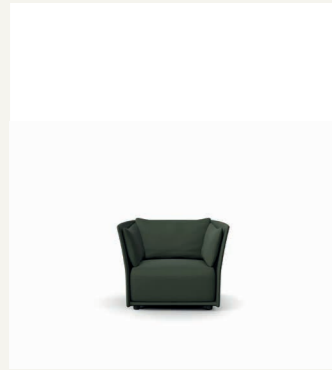

Obris - OBR01 Arm Chair

Dimensions:

Seat Height	16.25"
Seat Width	31"
Seat Depth	31.5"
Overall Height	30.25"
Overall Width	39.25"
Overall Depth	35.5"

Standard Features:

- Tubular Steel back frame with foam overmold and tensioned fabric
- Traditional carcass seat with dual density seat foam
- Solid Beech feet with a Black color wash finish
- Reversible plastic/felt glides

Obris - OBR02 2 Seater Sofa

Dimensions:

Seat Height	16.25"
Seat Width	66.5"
Seat Depth	31.5"
Overall Height	30.25"
Overall Width	74.75"
Overall Depth	35.5"

Standard Features:

- Tubular Steel back frame with foam overmold and tensioned fabric
- Traditional carcass seat with dual density seat foam
- Solid Beech feet with a Black color wash finish
- Reversible plastic/felt glides

Obris - OBR03 3 Seater Sofa

Dimensions:

Seat Height	16.25"
Seat Width	82"
Seat Depth	31.5"
Overall Height	30.25"
Overall Width	90.5"
Overall Depth	35.5"

Standard Features:

- Tubular Steel back frame with foam overmold and tensioned fabric
- Traditional carcass seat with dual density seat foam
- Solid Beech feet with a Black color wash finish
- Reversible plastic/felt glides

Orai

Design by Mark Gabbertas

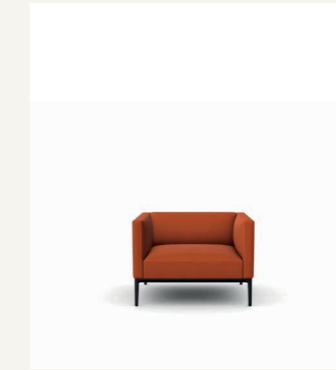

Orai

Standard Features:

- Fully upholstered
- Traditional carcass with multi-layered foam construction
- Tensioned seat support
- Cast Aluminum leg and perimeter frame finished in Black (Textured) powder coat
- Plastic glides

Optional Features:

- Felt Glides

Frame Finish:

Black (Textured) ████████

For larger swatches go to pg.188-205

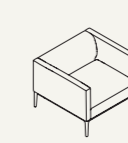

OH: 27.25"

ORI100 - Armchair
SH: 17.25"
SW: 27.25"
SD: 22.5"
OW: 37.75"
OD: 33.5"

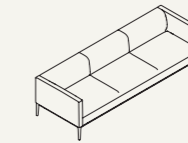

OH: 27.25"

ORI300 - 3 Seater Sofa
SH: 17.25"
SW: 92"
SD: 22.5"
OW: 101.5"
OD: 33.5"

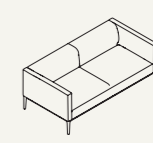

OH: 27.25"

ORI200 - 2 Seater Sofa
SH: 17.25"
SW: 60"
SD: 22.5"
OW: 70.5"
OD: 33.5"

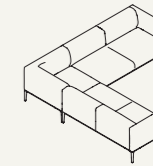

OH: 27.25"

ORI500 - Corner Unit
SH: 17.25"
SD: 22.5"
OW: 102.25"
OD: 102.25"

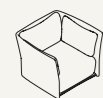

↓ Scan here to discover more



↓ Scan here to discover more



Oran

Design by Mark Gabbertas

120

121

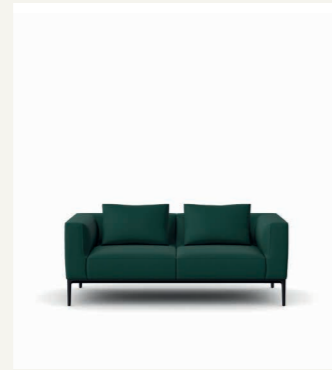
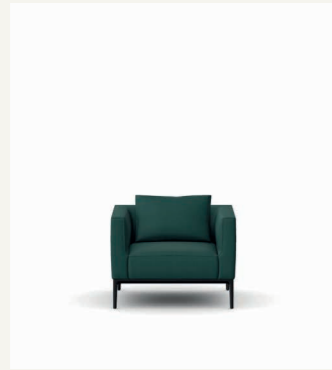

Oran Arm Chair

Dimensions:
 Seat Height 17.25"
 Seat Width 29"
 Seat Depth 29"
 Overall Height 27.5"
 Overall Width 37.5"
 Overall Depth 37"

Standard Features:

- Fully Upholstered
- Traditional carcass construction
- Tensioned seat support
- Feather webbed sprung seat foam
- Curled feather filled cushion with fire retardant inner cover
- Cast Aluminum legs and Aluminum perimeter frame finished in Black [Textured] powder coat
- Plastic glides

Optional Features:

- Two-tone upholstery
- Felt Guides

Frame Finish:

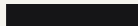
Black [Textured] 

For larger swatches go to pg.188-205

Oran 2 Seater Sofa

Dimensions:
 Seat Height 17.25"
 Seat Width 57.75"
 Seat Depth 29"
 Overall Height 27.5"
 Overall Width 73.5"
 Overall Depth 37"

Standard Features:

- Fully Upholstered
- Traditional carcass construction
- Tensioned seat support
- Feather webbed sprung seat foam
- Curled feather filled cushion with fire retardant inner cover
- Cast Aluminum legs and Aluminum perimeter frame finished in Black [Textured] powder coat
- Plastic glides

Optional Features:

- Two-tone upholstery
- Felt Guides

Frame Finish:

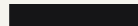
Black [Textured] 

For larger swatches go to pg.188-205

Oran 3 Seater Sofa

Dimensions:
 Seat Height 17.25"
 Seat Width 86.75"
 Seat Depth 29"
 Overall Height 27.5"
 Overall Width 102.25"
 Overall Depth 37"

Standard Features:

- Fully Upholstered
- Traditional carcass construction
- Tensioned seat support
- Feather webbed sprung seat foam
- Curled feather filled cushion with fire retardant inner cover
- Cast Aluminum legs and Aluminum perimeter frame finished in Black [Textured] powder coat
- Plastic glides

Optional Features:

- Two-tone upholstery
- Felt Guides

Frame Finish:

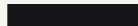
Black [Textured] 

For larger swatches go to pg.188-205

Oran

Design by Mark Gabbertas

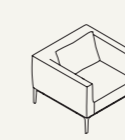

OH: 27.5"

ORA100 - Armchair
 SH: 17.25"
 SW: 29"
 SD: 29"
 OW: 37.5"
 OD: 37"

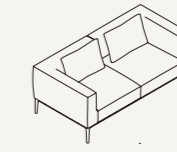

OH: 27.5"

ORA200 - 2 Seater Sofa
 SH: 17.25"
 SW: 67.75"
 SD: 29"
 OW: 73.5"
 OD: 37"

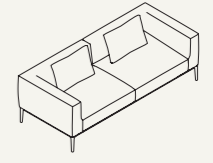

OH: 27.5"

ORA250 - 2 Seater Sofa - wide
 SH: 17.25"
 SW: 71.75"
 SD: 29"
 OW: 86.5"
 OD: 37"



OH: 27.5"

ORA300 - 3 Seater Sofa
 SH: 17.25"
 SW: 86.75"
 SD: 29"
 OW: 102.25"
 OD: 37"

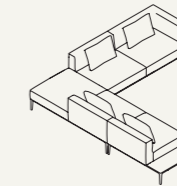

OH: 27.5"

ORA502 - L shape unit with table
 SH: 17.25"
 SD: 29"
 OW: 124"
 OD: 117.25"

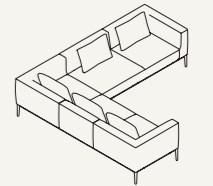

OH: 27.5"

ORA500 - L shape sofa
 SH: 17.25"
 SD: 29"
 OW: 102.25"
 OD: 110.5"

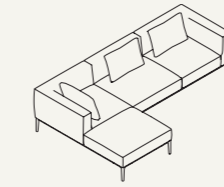

OH: 27.5"

ORA503 - Right hand chaise sofa
 SH: 17.25"
 SD: 29"
 OW: 110.5"
 OD: 66.5"

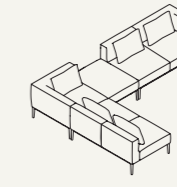

OH: 27.5"

ORA501 - L shape Unit
 SH: 17.25"
 SD: 29"
 OW: 102.25"
 OD: 110.5"

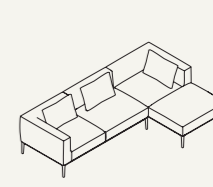

OH: 27.5"

ORA504 - Left hand chaise sofa
 SH: 17.25"
 SD: 29"
 OW: 110.5"
 OD: 66.5"

↓ Scan here to discover more



Paver

Design by Allermuir Design Studio

122

123



Paver

Standard Features:

- Traditional carcass construction
- Super soft foam upholstery
- Turned out top sewn seam
- Configurable linking plates x 2
- Plastic glides

Optional Features:

- Two-tone upholstery

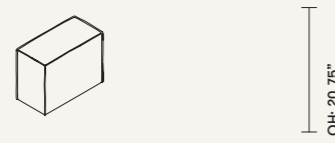

PVR25 - Arm
OW: 25.5"
OD: 12.75"

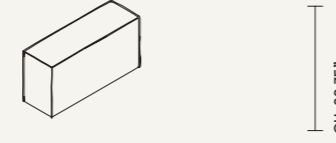

PVR38 - Arm
OW: 38.5"
OD: 12.75"

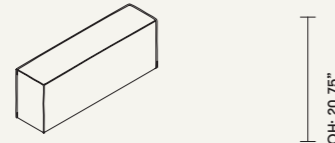
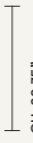

PVR51 - Arm
OW: 51.25"
OD: 12.75"

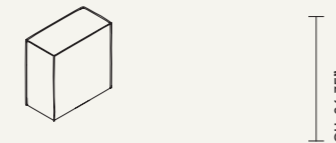

PVRB25 - Back
OW: 25.5"
OD: 12.75"

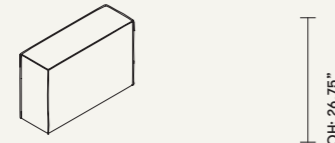
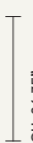

PVRB38 - Back
OW: 38.5"
OD: 12.75"

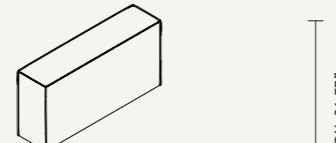

PVRB51 - Back
OW: 51.25"
OD: 12.75"

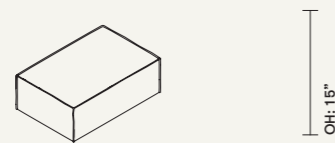
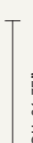

PVR38 - Rectangular Seat
OW: 38.5"
OD: 26.5"

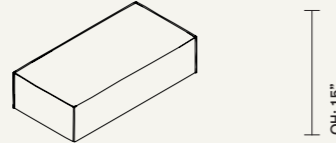

PVR51 - Rectangular Seat
OW: 51.25"
OD: 26.5"

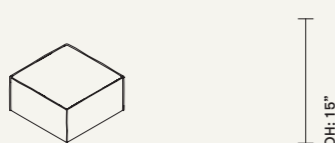

PVR25SQ - Square seat
OW: 25.5"
OD: 26.5"

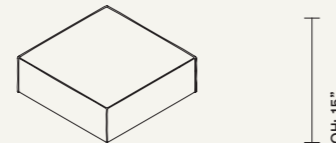

PVR38SQ - Square seat
OW: 38.5"
OD: 38.5"

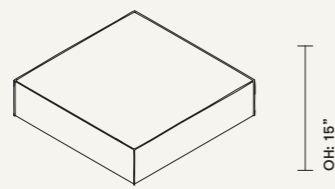

PVR51SQ - Square seat
OW: 51.25"
OD: 51.25"



Configurations:

Create your own using our product configurator at allermuir.com

1. PVR38 x 3
PVR25 x 2
PVRB38 x 2
PVR51
PVR38
2. PVR38 x 2
PVRB38 x 2
PVR38 x 2

1

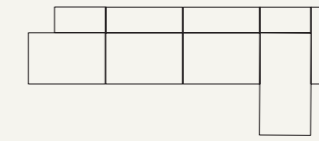

2

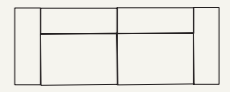

3. PVR38
PVRB25 x 6
PVR38 x 2
PVRB38
4. PVR25SQ x 3
PVRB25 x 3
PVR38 x 2

3

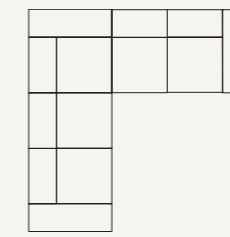

4

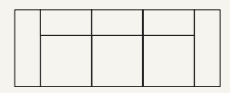

5. PVR51
PVR38 x 4
PVRB38 x 3
PVR38SQ x 2
PVR25SQ
PVR38
6. PVR51
PVRB38 x 2
PVR38
PVR38SQ

5

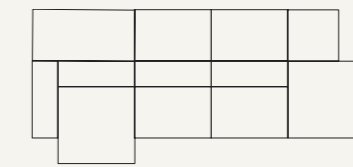

6

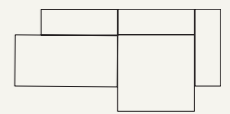

7. PVR38 x 2
PVRB51 x 2
PVR51
PVR25SQ x 3
8. PVR38SQ
PVRB38 x 2
PVR38
PVR51 x 2
PVR51
PVRB25
PVR25SQ x 2
PVR38

7

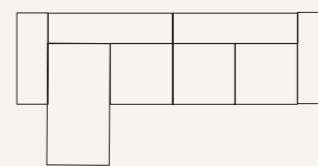

8

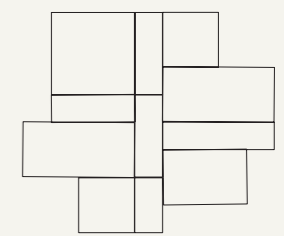

9. PVR51 x 2
PVR38
PVRB51 x 2
PVR51SQ
PVRB25
PVR25SQ
PVR25

9

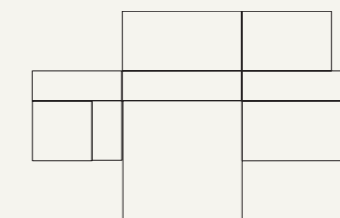

↓ Scan here to discover more



Plum

Design By Mark Gabbertas

124

125

Plum

Design By Mark Gabbertas

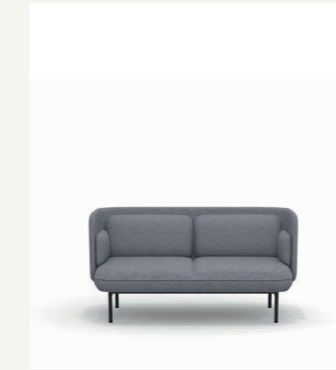
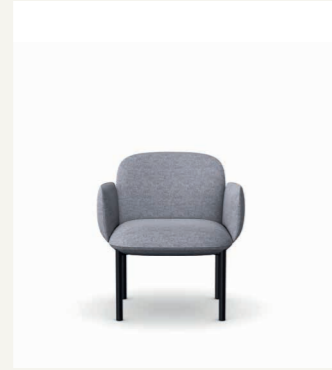

Plum - PLM01 Lounge Chair

Dimensions:

Seat Height	17.5"
Seat Width	20.75"
Seat Depth	19.25"
Overall Height	30.5"
Overall Width	23.5"
Overall Depth	26"

Standard Features:

- Molded foam construction
- Tubular Steel frame finished in Black powder coat
- Plastic glides

Optional Features:

- Plastic glides with felt

Frame Finish:

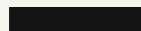
Black 

For larger swatches go to pg.188-205

Plum - PLM02 Lounge Chair with Arms

Dimensions:

Seat Height	17.5"
Seat Width	20.75"
Seat Depth	19.25"
Overall Height	30.5"
Overall Width	28.25"
Overall Depth	26"

Standard Features:

- Molded foam construction
- Molded foam arms
- Tubular Steel frame finished in Black powder coat
- Plastic glides

Optional Features:

- Plastic glides with felt

Frame Finish:

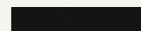
Black 

For larger swatches go to pg.188-205

Plum - PLM100 1 Seat Sofa

Dimensions:

Seat Height	18"
Seat Width	33.25"
Seat Depth	22.75"
Overall Height	33.75"
Overall Width	36.25"
Overall Depth	29.5"

Standard Features:

- Molded foam construction
- Molded foam arms
- Fully Upholstered
- Tubular Steel back frame with foam overmold and tensioned fabric
- Tubular Steel frame finished in Black powder coat
- Plastic glides

Optional Features:

- Plastic glides with felt
- Two-tone Upholstery

Frame Finish:

Black 

For larger swatches go to pg.188-205

Plum - PLM200 2 Seat Sofa

Dimensions:

Seat Height	18"
Seat Width	62.75"
Seat Depth	22.75"
Overall Height	33.75"
Overall Width	65.75"
Overall Depth	29.5"

Standard Features:

- Molded foam construction
- Molded foam arms
- Fully Upholstered
- Tubular Steel back frame with foam overmold and tensioned fabric
- Tubular Steel frame finished in Black powder coat
- Plastic glides

Optional Features:

- Plastic glides with felt
- Two-tone Upholstery

Frame Finish:

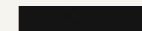
Black 

For larger swatches go to pg.188-205

Plum - PLM300 3 Seat Sofa

Dimensions:

Seat Height	18"
Seat Width	90.25"
Seat Depth	22.75"
Overall Height	33.75"
Overall Width	93.25"
Overall Depth	29.5"

Standard Features:

- Molded foam construction
- Molded foam arms
- Fully Upholstered
- Tubular Steel back frame with foam overmold and tensioned fabric
- Tubular Steel frame finished in Black powder coat
- Plastic glides

Optional Features:

- Plastic glides with felt
- Two-tone Upholstery

Frame Finish:

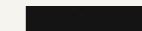
Black 

For larger swatches go to pg.188-205



↓ Scan here to discover more



↓ Scan here to discover more

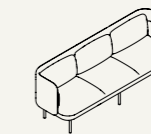
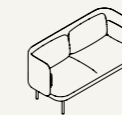

Plum

Design By Mark Gabbertas

126

127

Plum

Design By Mark Gabbertas

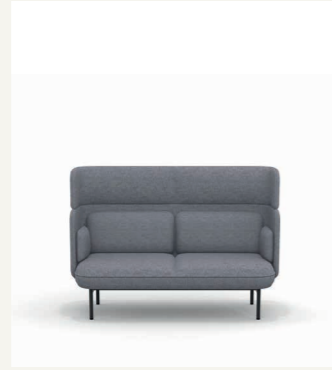
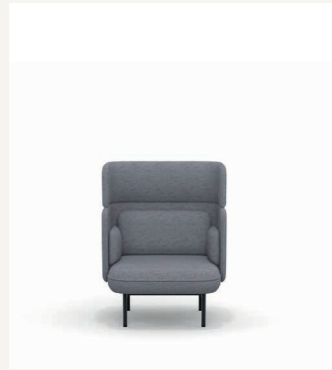

Plum - PLM100HR
1 Seat Sofa with Headrest

Dimensions:

Seat Height	18"
Seat Width	33.25"
Seat Depth	22.75"
Overall Height	46.25"
Overall Width	36.25"
Overall Depth	29.5"

Standard Features:

- Molded foam construction
- Molded foam arms
- Fully Upholstered
- Tubular Steel back frame with foam overmold and tensioned fabric
- Tubular Steel frame finished in Black powder coat
- Plastic glides

Optional Features:

- Plastic glides with felt
- Two-tone Upholstery

Frame Finish:

Black

For larger swatches go to pg.188-205

Plum - PLM200HR
2 Seat Sofa with Headrest

Dimensions:

Seat Height	18"
Seat Width	62.75"
Seat Depth	22.75"
Overall Height	46.25"
Overall Width	65.75"
Overall Depth	29.5"

Standard Features:

- Molded foam construction
- Molded foam arms
- Fully Upholstered
- Tubular Steel back frame with foam overmold and tensioned fabric
- Tubular Steel frame finished in Black powder coat
- Plastic glides

Optional Features:

- Plastic glides with felt
- Two-tone Upholstery

Frame Finish:

Black

For larger swatches go to pg.188-205

Plum - PLM300HR
3 Seat Sofa with Headrest

Dimensions:

Seat Height	18"
Seat Width	90.25"
Seat Depth	22.75"
Overall Height	46.25"
Overall Width	93.25"
Overall Depth	29.5"

Standard Features:

- Molded foam construction
- Molded foam arms
- Fully Upholstered
- Tubular Steel back frame with foam overmold and tensioned fabric
- Tubular Steel frame finished in Black powder coat
- Plastic glides

Optional Features:

- Plastic glides with felt
- Two-tone Upholstery

Frame Finish:

Black

For larger swatches go to pg.188-205

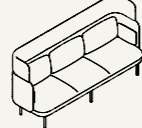

↓ Scan here to discover more



↓ Scan here to discover more

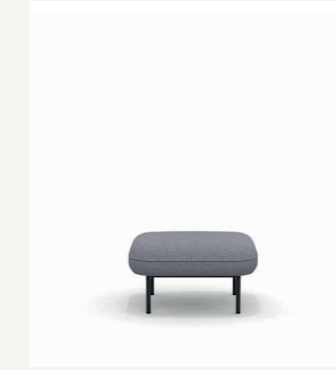

Pebble - PLM101
1 Seat Ottoman

Dimensions:

Seat Height	18"
Seat Width	33.25"
Seat Depth	28"

Standard Features:

- Molded foam construction
- Fully Upholstered
- Tubular Steel frame finished in Black powder coat
- Plastic glides

Optional Features:

- Plastic glides with felt

Frame Finish:

Black

For larger swatches go to pg.188-205

Pebble - PLM201
2 Seat Ottoman

Dimensions:

Seat Height	18"
Seat Width	62.75"
Seat Depth	28"

Standard Features:

- Molded foam construction
- Fully Upholstered
- Tubular Steel frame finished in Black powder coat
- Plastic glides

Optional Features:

- Plastic glides with felt

Frame Finish:

Black

For larger swatches go to pg.188-205

Pebble - PLM301
3 Seat Ottoman

Dimensions:

Seat Height	18"
Seat Width	90.25"
Seat Depth	28"

Standard Features:

- Molded foam construction
- Fully Upholstered
- Tubular Steel frame finished in Black powder coat
- Plastic glides

Optional Features:

- Plastic glides with felt

Frame Finish:

Black

For larger swatches go to pg.188-205

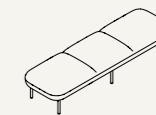

Stirling

Design by Allermuir Design Studio

128

129

Stirling

Design by Allermuir Design Studio

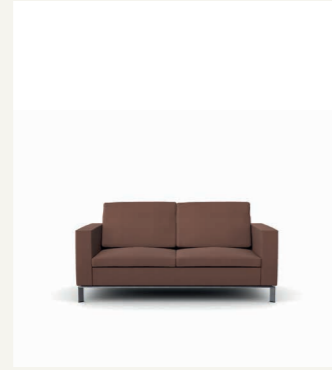
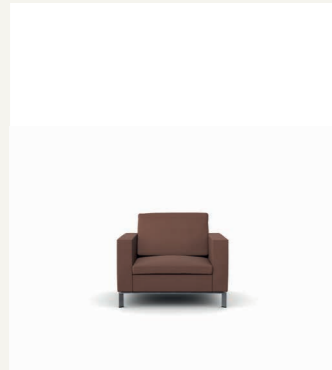

Stirling - SL01 Armchair with narrow arms

Dimensions:

Seat Height	17.75"
Seat Width	29.5"
Seat Depth	23.5"
Overall Height	35.5"
Overall Width	41.25"
Overall Depth	36.25"

Standard Features:

- Fully upholstered
- Zipped secured back cushions
- Coil sprung seat support
- Flat steel frame finished in Brushed Chrome
- Plastic glides

Optional Features:

- SLSC leather scatter cushion
- Two-tone upholstery
- SLWT writing tablet for wide arm*

Frame Finish:

Brushed Chrome 

For larger swatches go to pg.188-205

Also available with wide arms: SLW01

Stirling - SL02 Two seat sofa with narrow arms

Dimensions:

Seat Height	17.75"
Seat Width	59"
Seat Depth	23.5"
Overall Height	35.5"
Overall Width	70.75"
Overall Depth	36.25"

Standard Features:

- Fully upholstered
- Zipped secured back cushions
- Coil sprung seat support
- Flat steel frame finished in Brushed Chrome
- Plastic glides

Optional Features:

- SLSC leather scatter cushion
- Two-tone upholstery
- SLWT writing tablet for wide arm*

Frame Finish:

Brushed Chrome 

For larger swatches go to pg.188-205

Also available with wide arms: SLW02

Stirling - SL03 Three seat sofa with narrow arms

Dimensions:

Seat Height	17.75"
Seat Width	88.5"
Seat Depth	23.5"
Overall Height	35.5"
Overall Width	100.5"
Overall Depth	36.25"

Standard Features:

- Fully upholstered
- Zipped secured back cushions
- Coil sprung seat support
- Flat steel frame finished in Brushed Chrome
- Plastic glides

Optional Features:

- SLSC leather scatter cushion
- Two-tone upholstery
- SLWT writing tablet for wide arm*

Frame Finish:

Brushed Chrome 

For larger swatches go to pg.188-205

Wide arms also available : SLW03

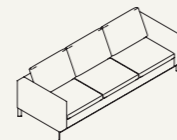
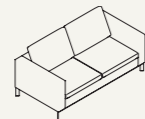
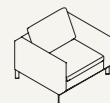

↓ Scan here to discover more



↓ Scan here to discover more

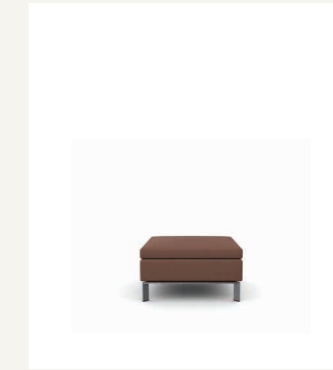

Stirling - SLB01 Single seat bench unit

Dimensions:

Overall Height	17.75"
Overall Width	29.5"
Overall Depth	29.5"

Standard Features:

- Traditional carcass construction
- Coil sprung seat support
- Flat steel frame finished in Brushed Chrome
- Plastic glides

Frame Finish:

Brushed Chrome 

For larger swatches go to pg.188-205

Stirling - SLB02 Two seat bench unit

Dimensions:

Overall Height	17.75"
Overall Width	59"
Overall Depth	29.5"

Standard Features:

- Traditional carcass construction
- Coil sprung seat support
- Flat steel frame finished in Brushed Chrome
- Plastic glides

Frame Finish:

Brushed Chrome 

For larger swatches go to pg.188-205

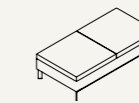
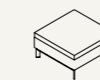

Contents

132	Axyl
134	Batan
137	Cirque
139	Conic
140	Folk
141	Folk Environmental
142	FortySeven
148	FortySeven XL
151	Host
152	Oran
153	Pache
156	Silta
158	Sunda 1
159	Sunda 2
160	Tibo
161	Turo
162	Turo Environmental

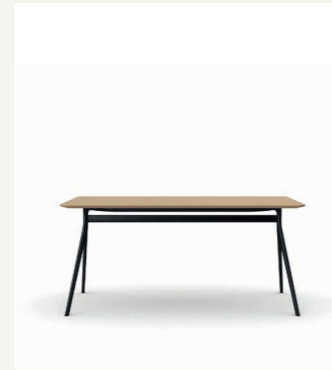
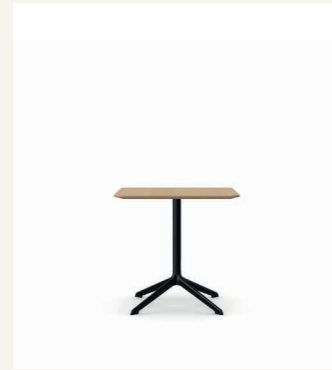
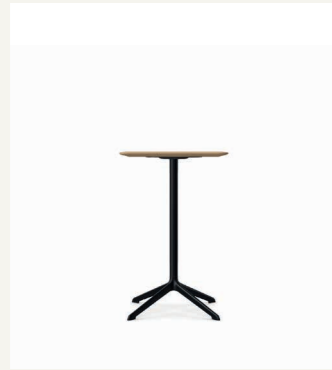

Axyl Bistro High level table

Dimensions:
Overall Height 40.25"

- Standard Features:
- 1" Laminate faced MDF core top with a clear edge finish (Edge 38)
 - Cast Aluminum base and Aluminum center column finished in Matte Black powder coat
 - Integral leg feet with leveling adjustment

- Optional Features:
- Cast Aluminum base and Aluminum center column available in a selection of powder coat finishes
 - Table edge profile can be stained in a selection of colors

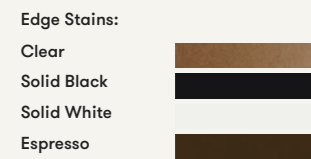
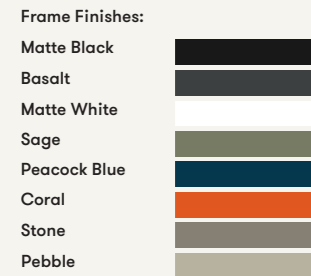

For larger swatches go to pg.188-205

16 optional Global Laminates are also available please go to pg. 196 to see more.

Axyl Bistro Dining level table

Dimensions:
Overall Height 29.25"

- Standard Features:
- 1" Laminate faced MDF core top with a clear edge finish (Edge 38)
 - Cast Aluminum base and Aluminum center column finished in Matte Black powder coat
 - Integral leg feet with leveling adjustment

- Optional Features:
- Cast Aluminum base and Aluminum center column available in a selection of powder coat finishes
 - Table edge profile can be stained in a selection of colors

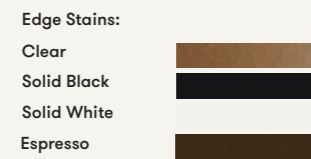
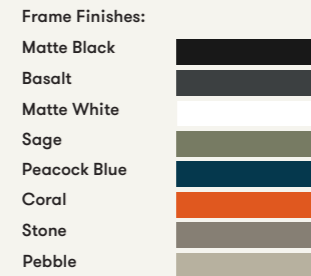

For larger swatches go to pg.188-205

16 optional Global Laminates are also available please go to pg. 196 to see more.

Axyl Dining Height table with rectangular top

Dimensions:
Overall Height 29.25"

- Standard Features:
- 1" Laminate faced MDF core top with a clear edge finish (Edge 38)
 - Cast Aluminum base and Aluminum center column finished in Matte Black powder coat
 - Integral leg feet with leveling adjustment
 - Inset legs at 12" available on select models only

- Optional Features:
- Cast Aluminum base and Aluminum center column available in a selection of powder coat finishes
 - Table edge profile can be stained in a selection of colors

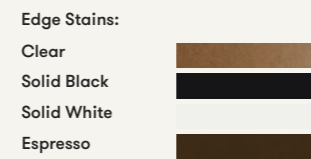
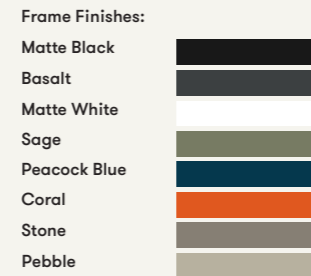

For larger swatches go to pg.188-205

16 optional Global Laminates are also available please go to pg. 196 to see more.

Bistro High

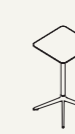

OH: 40.25"

AXLH24SQ - Square top
OW: 24"
OD: 24"



OH: 40.25"

AXLH30RD - Round top
Dia: 30"



OH: 40.25"

AXLH30SQ - Square top
OW: 30"
OD: 30"

Bistro Dining



OH: 29.25"

AXLD30RD - Round top
Dia: 30"



OH: 29.25"

AXLD30SQ - Square top
OW: 30"
OD: 30"



OH: 29.25"

AXLD36RD - Round top
Dia: 36"

Dining Height



OH: 29.25"

AXLR6036 - Rectangular top
OW: 60"
OD: 36"



OH: 29.25"

AXLR7836 - Rectangular top
OW: 78"
OD: 36"



OH: 29.25"

AXLR7836 - Rectangular top with inset legs
OW: 78"
OD: 36"



OH: 29.25"

AXLR9636 - Rectangular top with inset legs
OW: 96"
OD: 36"

↓ Scan here to discover more



Batan – Compact Plinth

Design by Allermuir Design Studio

134





Batan - Compact Plinth

Standard Features:

- Concrete base in Natural finish
- Steel stem in Brass finish
- Frosted glass top in Beige finish
- Radial top in Brass finish

Frame Finishes:

- Brass 
- Natural Concrete 

Top Finishes:

- Radial Brass 
- Frosted Glass Beige 

For larger swatches go to pg.188-205

Low

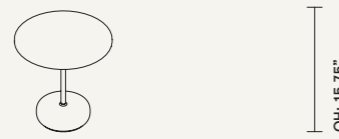

CPL16RDGLS - Low Glass
Dia: 15.75"

OH: 15.75"

Tall



CPH16RDGLS - Tall Glass
Dia: 15.75"

OH: 19.75"

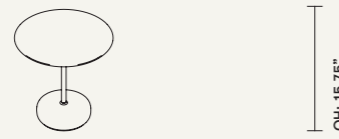

CPL16RDBRS - Low Brass
Dia: 15.75"

OH: 15.75"



CPH16RDBRS - Tall Brass
Dia: 15.75"

OH: 19.75"

135

Batan – Extruded Blend

Design by Allermuir Design Studio

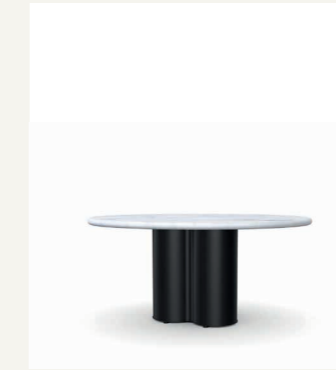

Batan - Extruded Blend







Standard Features:

- Aluminum extruded frame in a selection of powder coat finishes
- 0.75" thick White Marble top
- 0.75" thick Green Marble top
- 0.75" thick Terazzo top
- 0.75" thick Oak top in lacquer

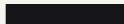

Optional Features:

- 0.75" thick Oak top in black or blue stain



Leg / Frame Finishes:

- Black [Textured] 
- Mineral Forest 
- Ultramarine Blue 
- Ceramic White 
- White [Textured] 
- Soft Gold 

Solid Stone Finishes:

- Green Marble 
- White Marble 
- Terazzo 

Solid Oak Top:

- Clear on Oak 
- Black Oak Stain 
- Blue Oak Stain 

For larger swatches go to pg.188-205

Low



EBL27RD - Low Round
Dia: 27.50"

OH: 13"



EBLP4020 - Low Pill
OW: 39.25"
OD: 19.75"

OH: 13"

Medium

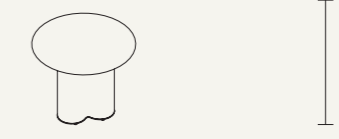

EBM20RD - Mid Round
Dia: 19.75"

OH: 15.75"

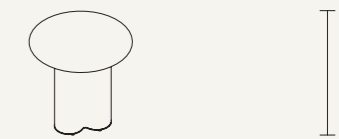

EBH20RD - Tall Round
Dia: 19.75"

OH: 19"

↓ Scan here to discover more



↓ Scan here to discover more



Batan – Soft Folds

Design by Allermuir Design Studio

136



Low



SFL30RD - Low Round
Dia: 31.5"

Tall



SFH16RD - Tall Round
Dia: 15.75"



SFLP4020 - Low Pill
OW: 39.25"
OD: 19.75"

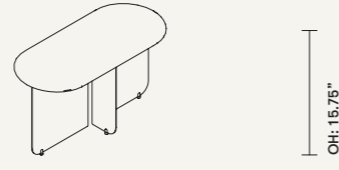

SFHP2914 - Tall Pill
OW: 29.5"
OD: 13.75"

Medium

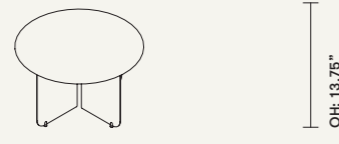

SFM24RD - Mid Round
Dia: 15.75"

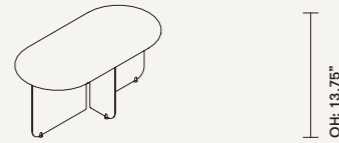







SFMP3016 - Mid Pill
OW: 31.5"
OD: 15.75"

Batan - Soft Folds

Standard Features:

- Folded steel frame and formed steel top finished in a selection of powder coat finishes
- Color matched leveling feet

Frame Finishes:

Black (Textured)	
Forest Green (Textured)	
Ultramarine Blue	
Blush	
White (Textured)	
Ivory	

For larger swatches go to pg.188-205

Cirque

Design by Allermuir Design Studio

137



Low

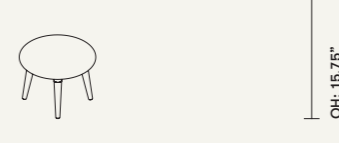

CRQC24RD - Round
Dia: 24"

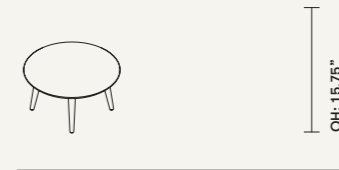

CRQC30RD - Round
Dia: 30"

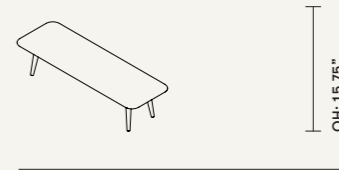

CRQC7224 - Soft Rectangle
OW: 72"
OD: 24"

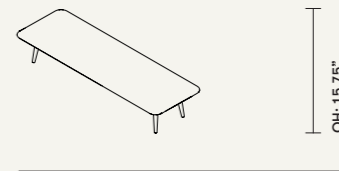

CRQC9430 - Soft Rectangle
OW: 94"
OD: 30"

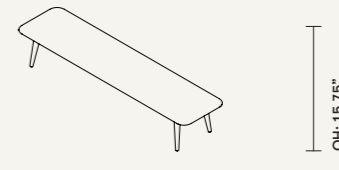

CRQC9424 - Soft Rectangle
OW: 94"
OD: 24"

Cirque

Standard Features:

- 1" Laminate faced MDF core top with a clear edge finish (Edge 37)
- Solid Ash legs with a clear finish
- Steel subframe finished in Slate Gray powder coat
- Plastic glides

Optional Features:

- Table edge profile can be stained in a selection of colors
- Solid Ash legs can be stained or color washed

Frame Finish:

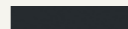
Slate Gray 





Solid Wood Leg Finish:

Clear on Ash 

Wood Stains based on Ash:

Clear	
White Oak	
American Cherry	
American Walnut	
Dark Walnut	
Wenge	

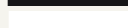
Edge Stains:

Clear	
Solid Black	
Solid White	
Espresso	

For larger swatches go to pg.188-205

16 optional standard color washes based on Ash and 16 optional Global Laminates are also available please go to pg. 194 and 196 to see more.

↓ Scan here to discover more



↓ Scan here to discover more



Cirque

Design by Allermuir Design Studio

138

139

Conic

Design by Pearson Lloyd



Dining - Round



CRQD24RD
Dia: 24"

Dining - Soft Square



CRQD2424
OW: 24"
OD: 24"

Dining - Soft Rectangle



CRQD4830
OW: 48"
OD: 30"



CRQD30RD
Dia: 30"



CRQD3030
OW: 30"
OD: 30"



CRQD7240
OW: 72"
OD: 40"



CRQD40RD
Dia: 40"



CRQD4040
OW: 40"
OD: 40"



CRQDT11
OW: 94"
OD: 30"



CRQD48RD
Dia: 48"

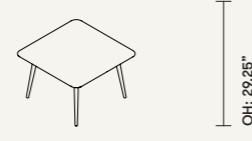

CRQD4848
OW: 48"
OD: 48"

Cirque

Standard Features:

- 1" Laminate faced MDF core top with a clear edge finish
- Solid Ash legs with a clear finish
- Steel subframe finished in Slate Gray powder coat
- Plastic glides

Optional Features:

- Table edge profile can be stained in a selection of colors
- Solid Ash legs can be stained or color washed

Frame Finish:

Slate Gray

Solid Wood Leg Finish:

Clear on Ash

Wood Stains based on Ash:

- Clear
- White Oak
- American Cherry
- American Walnut
- Dark Walnut
- Wenge

Edge Stains:

- Clear
- Solid Black
- Solid White
- Espresso

For larger swatches go to pg.188-205

16 optional standard color washes based on Ash and 16 optional Global Laminates are also available please go to pg. 194 and 196 to see more.

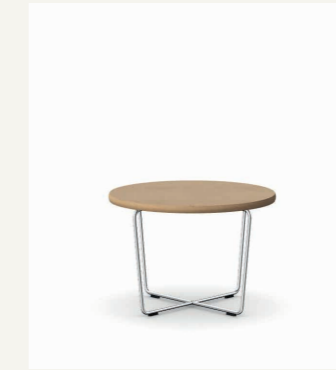

Low - Round



A636-24D
Dia: 24"

Low - Soft Square

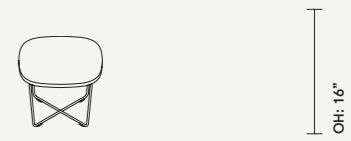

A636-21SS
OW: 21"
OD: 21"



A638-36RD
Dia: 36"

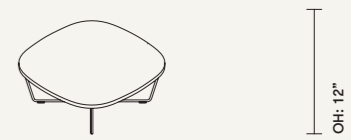

A638-32SS
OW: 32"
OD: 32"

Low - Soft Rectangle



A639-4128S
OW: 41"
OD: 28"

Conic

Standard Features:

- 1" Laminate faced MDF core top with a clear edge finish
- Wire frame finished in Polished Chrome
- Plastic glides

Optional Features:

- Table edge profile can be stained in a selection of colors
- Wire frame available in a selection of colors

Frame Finishes:

- Polished Chrome
- Silver M04
- New Black
- White
- Soft Gold
- Soft Silver
- Dark Bronze
- Deep Mulberry

Edge Stains:

- Clear (Standard)
- Solid Black
- Solid White
- Espresso

For larger swatches go to pg.188-205

16 optional Global Laminates also available please go to pg. 196 to see more.

↓ Scan here to discover more



↓ Scan here to discover more



Folk

Design by Pearson Lloyd

140

141



Dining - Round

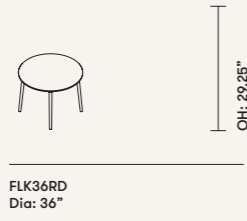

FLK36RD
Dia: 36"

Dining - Square

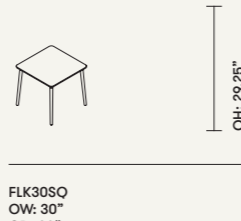

FLK30SQ
OW: 30"
OD: 30"

Folk

Standard Features:

- 0.75" Laminate faced MDF core top with a contrasting edge tape
- 0.75" Laminate faced Plywood core top with a clear finish exposed edge detail
- Aluminum corner joint and Steel frame under structure finished in Off Black powder coat
- Solid Ash legs with a clear finish
- Plastic glides with leveling adjustment

Optional Features:

- Aluminum corner joint and Steel framework available in a selection of powder coat finishes
- Solid Ash legs can be color washed or stained in a selection of colors
- MDF core with contrasting edge tape: Oak, White, Black or Ply

Frame Finishes:

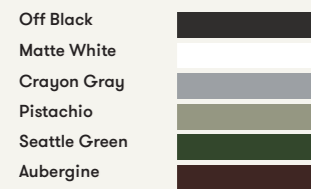

Wood Stains based on Ash:



Color Washes based on Ash:

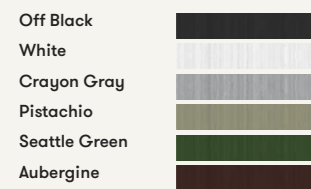

For larger swatches go to pg.188-205

16 optional Global Laminates are also available please go to pg. 196 to see more.



FLK42RD
Dia: 42"



FLK48SQ
OW: 48"
OD: 48"



FLK48RD
Dia: 48"

Dining - Rectangular



FLK603ORC
OW: 60"
OD: 30"



FLK8436RC
OW: 84"
OD: 36"

Folk Environmental

Design by Pearson Lloyd



Dining - Round



FLK39RDR
Dia: 39"

Dining - Square

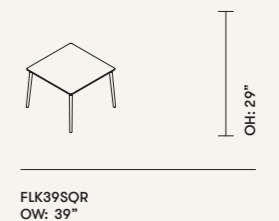

FLK39SQR
OW: 39"
OD: 39"

Folk

Standard Features:

- 1" Cotton Cream Kvadrat Really Board with Cream 2mm edge tape
- Aluminium Fluted legs and Steel frame under structure finished in Off Black powder coat
- Plastic glides with leveling adjustment

Optional Features:

- 1" Cotton White Kvadrat Really Board with Black 2mm edge tape
- 1" Cotton Blue Kvadrat Really Board with Oak effect 2mm edge tape
- Aluminium Fluted legs and Steel frame under structure available in Matte White, Sage or Pebble powder coat

Top Finishes:

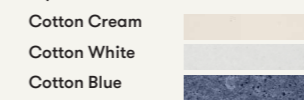

Edge Finishes:



Frame Finishes:

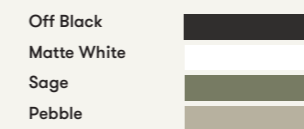

For larger swatches go to pg.188-205

Dining - Rectangular



FLK6332RCR
OW: 63"
OD: 32"

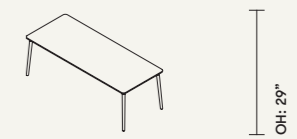

FLK8636RCR
OW: 86"
OD: 36"

↓ Scan here to discover more



↓ Scan here to discover more



FortySeven

Design by Allermuir Design Studio

142

143

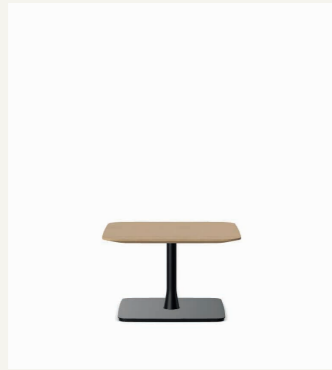

Coffee Height - Round

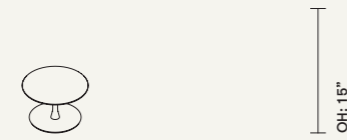

FRSC24RD
Dia: 24"

Coffee Height - Square

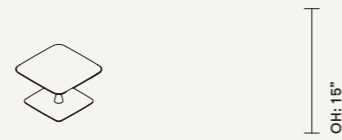

FRSC24SQ
OW: 24"
OD: 24"



FRSC30RD
Dia: 30"

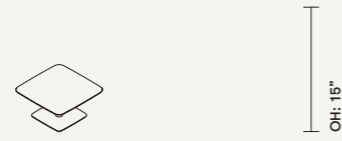

FRSC30SQ
OW: 30"
OD: 30"

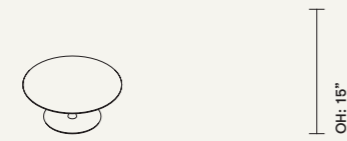

FRSC36RD
Dia: 36"

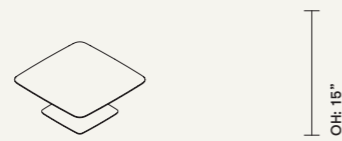

FRSC36SQ
OW: 36"
OD: 36"

Fortyseven Coffee height table

Dimensions:
Overall Height 15"



Standard Features:

- 1" Laminate faced MDF with contrasting edge tape
- 1" Laminate faced MDF core top with a clear edge profile
- 1" TFL top with matching edge tape
- Steel pedestal base finished in Matte Black powder coat
- Plastic glides with leveling adjustment

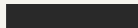

Optional Features:

- Steel pedestal base available in a selection colors
- Table edge profile can be stained in a selection of colors
- MDF core with contrasting edge tape: Oak, White, Black or Ply

Frame Finishes:

- Matte Black 
- Matte White 
- Stone 

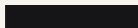
Edge Stains:

- Clear (Standard) 
- Solid Black 
- Solid White 
- Espresso 

For larger swatches go to pg.188-205

12 TFL finishes and 16 optional Global Laminates are also available please go to pg. 196 and 198 to see more.

FortySeven

Design by Allermuir Design Studio

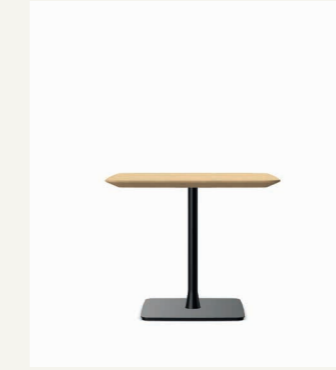

Work Lounge



FRSW30RD - Round
Dia: 30"

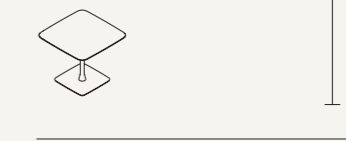

FRSW30SQ - Square
OW: 30"
OD: 30"

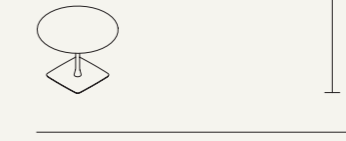

FRSW36RD - Round
Dia: 36"

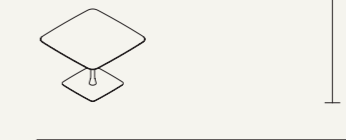

FRSW36SQ - Square
OW: 36"
OD: 36"

Fortyseven Work lounge table

Dimensions:
Overall Height 25"

Standard Features:

- 1" Laminate faced MDF with contrasting edge tape
- 1" Laminate faced MDF core top with a clear edge profile
- 1" TFL top with matching edge tape
- Steel pedestal base finished in Matte Black powder coat
- Plastic glides with leveling adjustment



Optional Features:

- Steel pedestal base available in a selection colors
- Table edge profile can be stained in a selection of colors
- MDF core with contrasting edge tape: Oak, White, Black or Ply

Frame Finishes:

- Matte Black 
- Matte White 
- Stone 

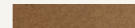
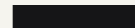
Edge Stains:

- Clear (Standard) 
- Solid Black 
- Solid White 
- Espresso 

For larger swatches go to pg.188-205

12 TFL finishes and 16 optional Global Laminates are also available please go to pg. 196 and 198 to see more.

↓ Scan here to discover more



↓ Scan here to discover more



FortySeven

Design by Allermuir Design Studio

144

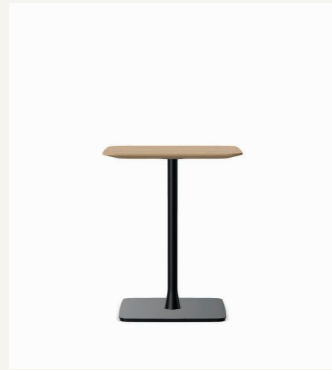

Dining

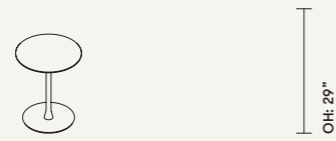

FRSD24RD - Round
Dia: 24"

OH: 29"

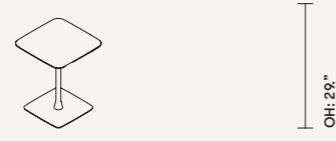

FRSD24SQ - Square
OW: 24"
OD: 24"

OH: 29"



FRSD30RD - Round
Dia: 30"

OH: 29"

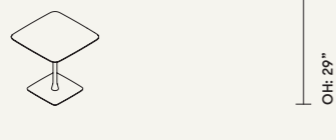

FRSD30SQ - Square
OW: 30"
OD: 30"

OH: 29"

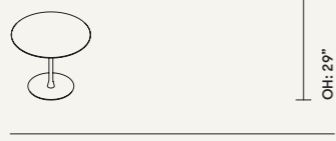

FRSD36RD - Round
Dia: 36"

OH: 29"



FRSD36SQ - Square
OW: 36"
OD: 36"

OH: 29"

Fortyseven Dining height table

Dimensions:
Overall Height 29"

Standard Features:

- 1" Laminate faced MDF with contrasting edge tape
- 1" Laminate faced MDF core top with a clear edge profile
- 1" TFL top with matching edge tape
- Steel pedestal base finished in Matte Black powder coat
- Plastic glides with leveling adjustment

Optional Features:

- Steel pedestal base available in a selection colors
- Table edge profile can be stained in a selection of colors
- MDF core with contrasting edge tape: Oak, White, Black or Ply

Frame Finishes:



Edge Stains:

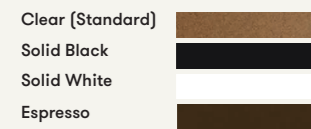

For larger swatches go to pg.188-205

12 TFL finishes and 16 optional Global Laminates are also available please go to pg. 196 and 198 to see more.

↓ Scan here to discover more



↓ Scan here to discover more



FortySeven

Design by Allermuir Design Studio

145

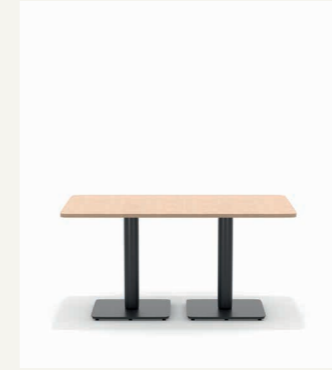

Dining - Rectangular

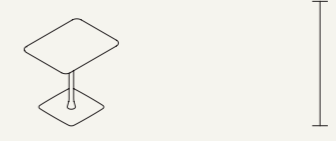

FRSD3024RC
OW: 30"
OD: 24"

OH: 29"

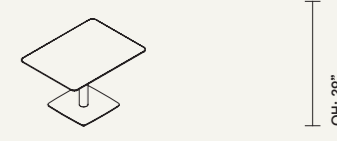

FRSD4836RC
OW: 48"
OD: 36"

OH: 29"



FRSD3624RC
OW: 36"
OD: 24"

OH: 29"

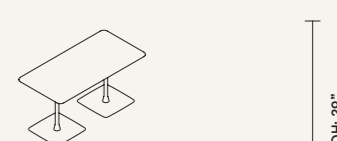

FRSD6030RC
OW: 60"
OD: 30"

OH: 29"

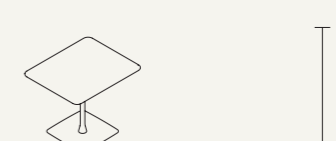

FRSD3630RC
OW: 36"
OD: 30"

OH: 29"

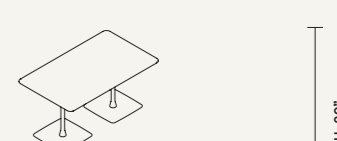

FRSD6036RC
OW: 60"
OD: 36"

OH: 29"

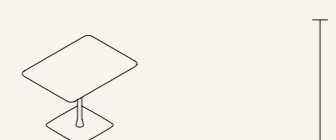

FRSD4230RC
OW: 42"
OD: 30"

OH: 29"

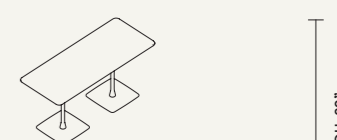

FRSD7230RC
OW: 72"
OD: 30"

OH: 29"

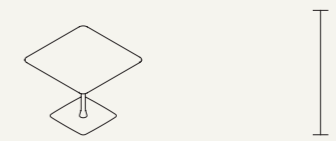

FRSD4236RC
OW: 42"
OD: 36"

OH: 29"

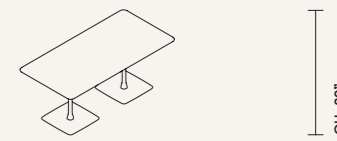

FRSD7236RC
OW: 72"
OD: 36"

OH: 29"



FRSD4830RC
OW: 48"
OD: 30"

OH: 29"

Fortyseven Dining table with rectangular top

Dimensions:
Overall Height 29"

Standard Features:

- 1" Laminate faced MDF with contrasting edge tape
- 1" Laminate faced MDF core top with a clear edge profile
- 1" TFL top with matching edge tape
- Steel pedestal base finished in Matte Black powder coat
- Plastic glides with leveling adjustment

Optional Features:

- Steel pedestal base available in a selection colors
- Table edge profile can be stained in a selection of colors
- MDF core with contrasting edge tape: Oak, White, Black or Ply

Frame Finishes:



Edge Stains:

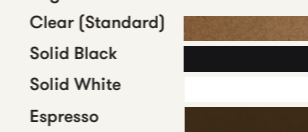

For larger swatches go to pg.188-205

12 TFL finishes and 16 optional Global Laminates are also available please go to pg. 196 and 198 to see more.

FortySeven

Design by Allermuir Design Studio

146

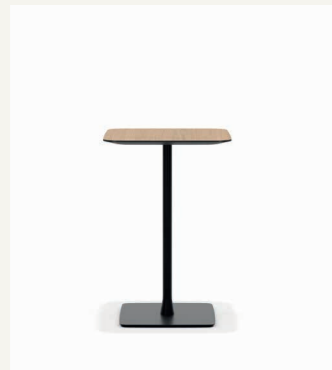

Counter Height

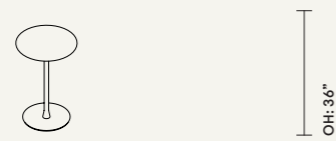

FRSCH24RD - Round
Dia: 24"

OH: 36"



FRSCH24SQ - Square
OW: 24"
OD: 24"

OH: 36"

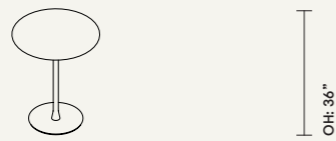

FRSCH30RD - Round
Dia: 30"

OH: 36"

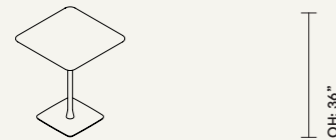

FRSCH30SQ - Square
OW: 30"
OD: 30"

OH: 36"

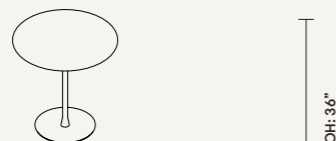

FRSCH36RD - Round
Dia: 36"

OH: 36"

Fortyseven Counter height table

Dimensions:
Overall Height 36"

Standard Features:

- 1" Laminate faced MDF with contrasting edge tape
- 1" Laminate faced MDF core top with a clear edge profile
- 1" TFL top with matching edge tape
- Steel pedestal base finished in Matte Black powder coat
- Plastic glides with leveling adjustment

Optional Features:

- Steel pedestal base available in a selection colors
- Table edge profile can be stained in a selection of colors
- MDF core with contrasting edge tape: Oak, White, Black or Ply

Frame Finishes:

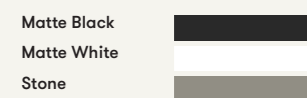

Edge Stains:

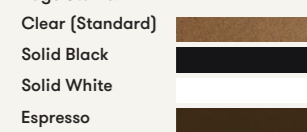

For larger swatches go to pg.188-205

12 TFL finishes and 16 optional Global Laminates are also available please go to pg. 196 and 198 to see more.

147

FortySeven

Design by Allermuir Design Studio

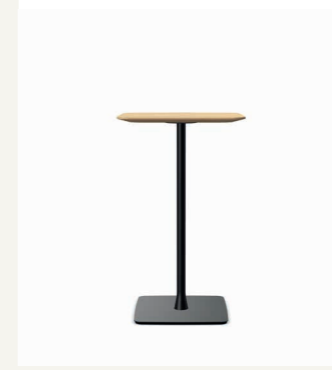

High

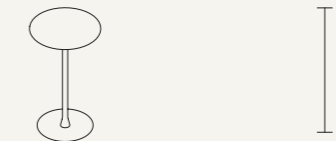

FRSP24RD - Round
Dia: 24"

OH: 40"

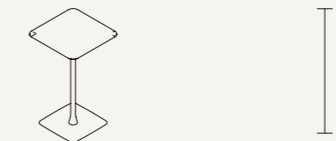

FRSP24SQ - Square
OW: 24"
OD: 24"

OH: 40"

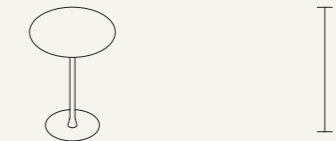

FRSP30RD - Round
Dia: 30"

OH: 40"



FRSP30SQ - Square
OW: 30"
OD: 30"

OH: 40"



FRSP36RD - Round
Dia: 36"

OH: 40"

Fortyseven High level table

Dimensions:
Overall Height 40"

Standard Features:

- 1" Laminate faced MDF with contrasting edge tape
- 1" Laminate faced MDF core top with a clear edge profile
- 1" TFL top with matching edge tape
- Steel pedestal base finished in Matte Black powder coat
- Plastic glides with leveling adjustment

Optional Features:

- Steel pedestal base available in a selection colors
- Table edge profile can be stained in a selection of colors
- MDF core with contrasting edge tape: Oak, White, Black or Ply

Frame Finishes:

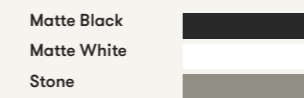

Edge Stains:

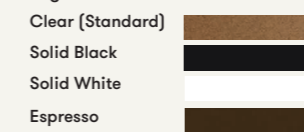

For larger swatches go to pg.188-205

12 TFL finishes and 16 optional Global Laminates are also available please go to pg. 196 and 198 to see more.

↓ Scan here to discover more



↓ Scan here to discover more



FortySeven XL

Design by Allermuir Design Studio

148

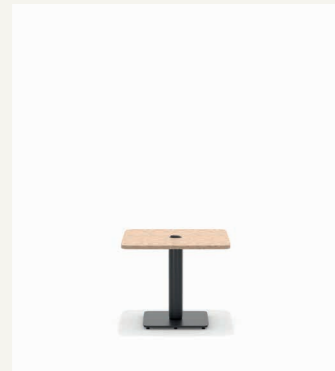

XL Work Lounge



OH: 25"

FRSXW30RD - Round
Dia: 30"



OH: 25"

FRSXW30SQ - Square
OW: 30"
OD: 30"



OH: 25"

FRSXW36RD - Round
Dia: 36"



OH: 25"

FRSXW36SQ - Square
OW: 36"
OD: 36"



OH: 25"

FRSXW42RD - Round
Dia: 42"

Fortyseven XL Work lounge table

Dimensions:
Overall Height 25"

Standard Features:

- 1" Laminate faced MDF with contrasting edge tape
- 1" Laminate faced MDF core top with a clear edge profile
- 1" TFL top with matching edge tape
- Steel pedestal base finished in Matte Black powder coat
- Plastic glides with leveling adjustment

Optional Features:

- Steel pedestal base available in a selection colors
- Table edge profile can be stained in a selection of colors
- MDF core with contrasting edge tape: Oak, White, Black or Ply

Frame Finishes:

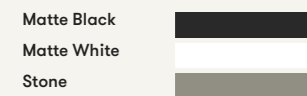

Edge Stains:

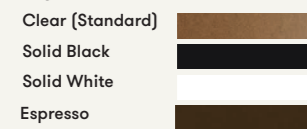

For larger swatches go to pg.188-205

12 TFL finishes and 16 optional Global Laminates are also available please go to pg. 196 and 198 to see more.

↓ Scan here to discover more



↓ Scan here to discover more



FortySeven XL

Design by Allermuir Design Studio

149

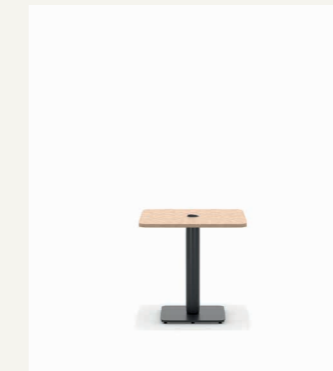

XL Dining



OH: 29"

FRSXLD30RD - Round
Dia: 30"



OH: 29"

FRSXLD48RD - Round
Dia: 48"

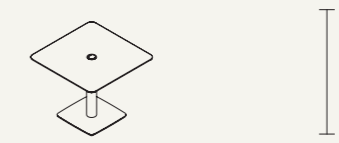

OH: 29"

FRSXLD30SQ - Square
OW: 30"
OD: 30"

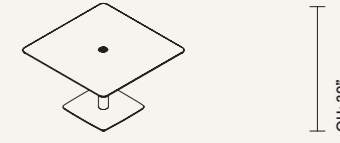

OH: 29"

FRSXLD48SQ - Square
OW: 48"
OD: 48"

Fortyseven XL Dining height table

Dimensions:
Overall Height 29"

Standard Features:

- 1" Laminate faced MDF with contrasting edge tape
- 1" Laminate faced MDF core top with a clear edge profile
- 1" TFL top with matching edge tape
- Steel pedestal base finished in Matte Black powder coat
- Plastic glides with leveling adjustment

Optional Features:

- Steel pedestal base available in a selection colors
- Table edge profile can be stained in a selection of colors
- MDF core with contrasting edge tape: Oak, White, Black or Ply

Frame Finishes:



Edge Stains:

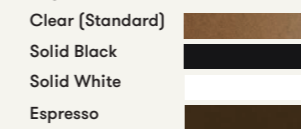

For larger swatches go to pg.188-205

12 TFL finishes and 16 optional Global Laminates are also available please go to pg. 196 and 198 to see more.

↓ Scan here to discover more



↓ Scan here to discover more

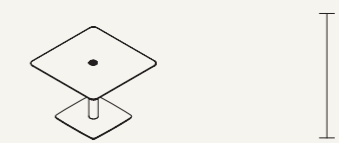

OH: 29"

FRSXLD42RD - Round
Dia: 42"

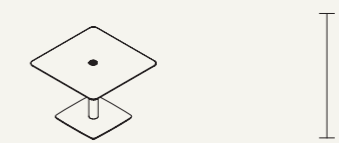

OH: 29"

FRSXLD42SQ - Square
OW: 42"
OD: 42"

FortySeven XL

Design by Allermuir Design Studio

150

151

Host

Design by Simon Pengelly

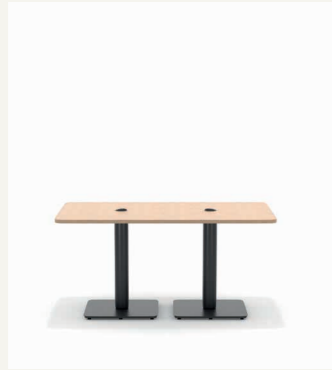

XL Dining - Rectangular

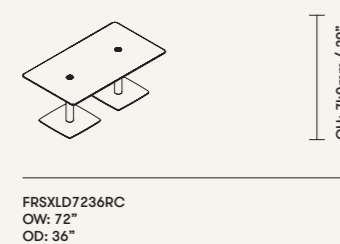
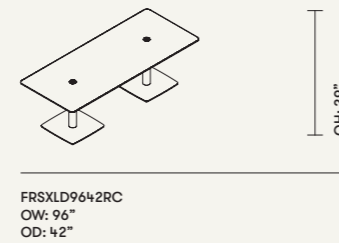
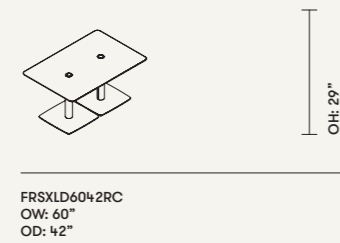
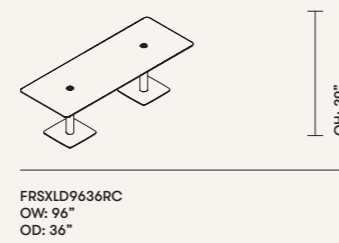
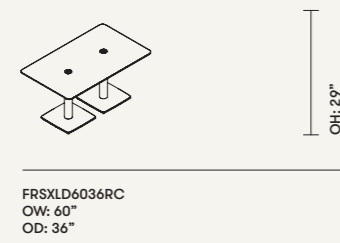
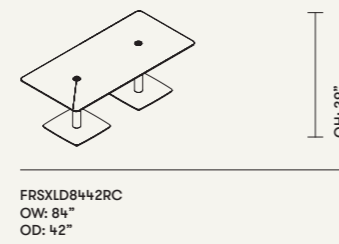
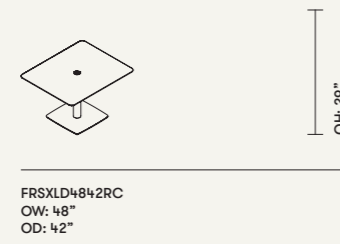
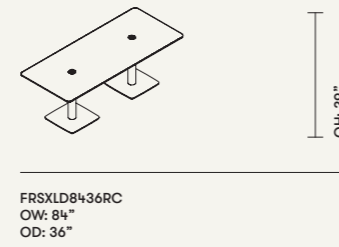
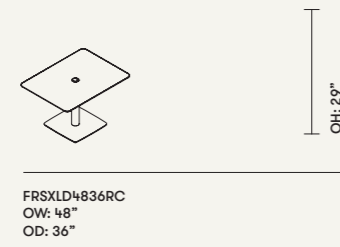
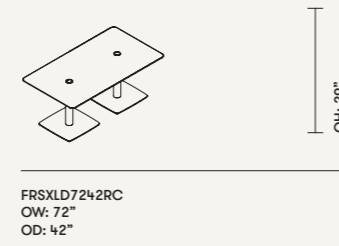
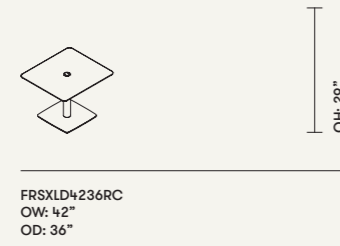

Fortyseven XL Dining table with rectangular top

Dimensions:
Overall Height 29"

Standard Features:

- 1" Laminate faced MDF with contrasting edge tape
- 1" Laminate faced MDF core top with a clear edge profile
- 1" TFL top with matching edge tape
- Steel pedestal base finished in Matte Black powder coat
- Plastic glides with leveling adjustment

Optional Features:

- Steel pedestal base available in a selection of colors
- Table edge profile can be stained in a selection of colors
- MDF core with contrasting edge tape: Oak, White, Black or Ply

Frame Finishes:

- Matte Black
- Matte White
- Stone

Edge Stains:

- Clear (Standard)
- Solid Black
- Solid White
- Espresso

For larger swatches go to pg.188-205

12 TFL finishes and 16 optional Global Laminates are also available please go to pg. 196 and 198 to see more.

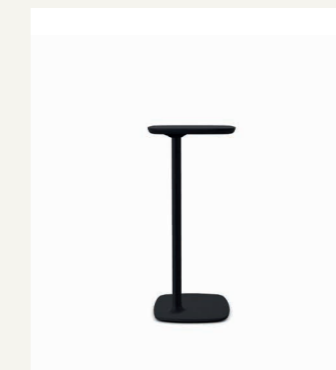

Host — HLT2 Occasional table

Dimensions:
Overall Height 23.5"
Overall Width 13.5"
Overall Depth 13.5"

Standard Features:

- Aluminum table construction available in a selection of colors
- Teflon glides

Finishes:

- Black (Textured)
- Touch of Gray
- White as Snow
- Blue Skies
- Mellow Yellow
- Orange Crush
- Vintage Red

For larger swatches go to pg.188-205

↓ Scan here to discover more



↓ Scan here to discover more



Oran

Design by Mark Gabbertas

152

153

Pache

Design by Allermuir Design Studio

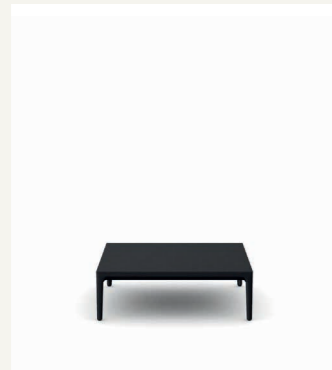

Coffee Height

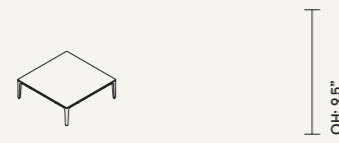

ORAT7373
OW: 29"
OD: 29"

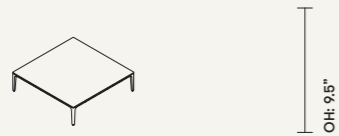

ORAT9191
OW: 35.75"
OD: 35.75"

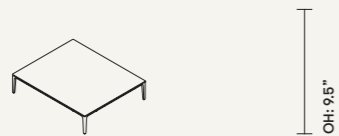

ORAT1091
OW: 42.75"
OD: 35.75"

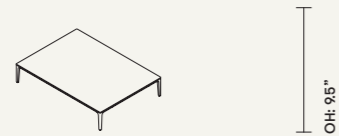

ORAT1291
OW: 60.5"
OD: 35.75"

Oran Coffee Table

Standard Features:

- Laminate faced MDF core top available in Matte Black or Tusk Gray
- 0.25" Visible edge profile stained to match the Laminate top
- Cast Aluminum legs and Aluminum perimeter frame finished in Black (Textured) powder coat
- Plastic glides

Frame Finish:

Black (Textured) 

Matte Laminates:

Black 

Tusk Gray 

For larger swatches go to pg.188-205



Pache Dining Height Table

Standard Features:

- 1" Laminate faced MDF core top with a clear edge profile
- 1" Laminate faced plywood core top with a clear finish exposed edge detail
- Solid ash legs with a clear finish
- Aluminum framework available in Black powder coat
- Plastic glides



Optional Features:

- Table edge profile can be stained
- Aluminum framework available in a selection of powder coat finishes
- Solid Ash legs available in Black color wash

Frame Finishes:

White 
 Black 
 Stone 

Edge Stains:

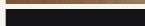
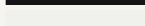
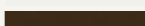
Plywood Clear 
 Clear 
 Solid Black 
 Solid White 
 Espresso 

Wood Finish:

Clear on Ash 

Color Wash based on Ash:

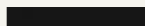
Back to Black 

For larger swatches go to pg.188-205

16 optional Global Laminates are also available please go to pg.196 to see more.

Dining - Round



PAC36RD
Dia: 36"



PAC42RD
Dia: 42"



PAC48RD
Dia: 48"

Dining - Square



PAC3636
OW: 36"
OD: 36"



PAC4242
OW: 42"
OD: 42"

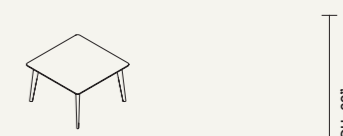

PAC4848
OW: 48"
OD: 48"



Pache

Design by Allermuir Design Studio

154



Dining - Rectangular



PAC4830R
OW: 48"
OD: 30"

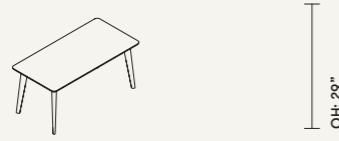

PAC6030R
OW: 60"
OD: 30"

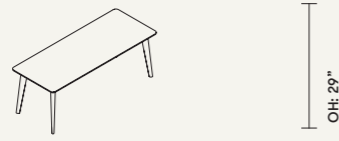

PAC7830R
OW: 78"
OD: 30"

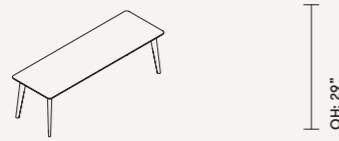

PAC9630R
OW: 96"
OD: 30"

Pache Dining Height Table with a Rectangular Top

Standard Features:

- 1" Laminate faced MDF core top with a clear edge profile
- 1" Laminate faced plywood core top with a clear finish exposed edge detail
- Solid ash legs with a clear finish
- Aluminum framework available in Black powder coat
- Plastic glides

Optional Features:

- Table edge profile can be stained
- Aluminum framework available in a selection of powder coat finishes
- Solid Ash legs available in Black color wash

Frame Finishes:

- White
- Black
- Stone

Edge Stains:

- Plywood Clear
- Clear
- Solid Black
- Solid White
- Espresso

Wood Finish:

- Clear on Ash

Color Wash based on Ash:

- Back to Black

For larger swatches go to pg.188-205

16 optional Global Laminates are also available please go to pg. 196 to see more.

155

Pache

Design by Allermuir Design Studio

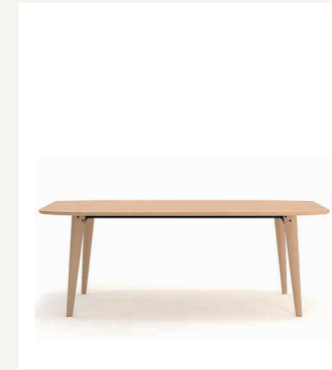

Dining - Soft Rectangle

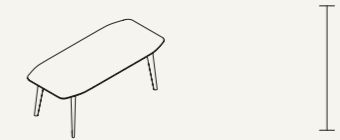

PAC7836SC
OW: 78"
OD: 36"

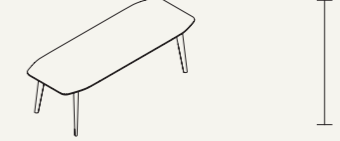

PAC9636SC
OW: 96"
OD: 36"



PAC12036SC
OW: 120"
OD: 36"

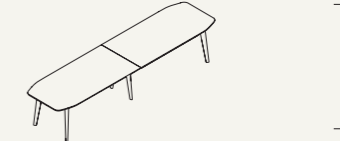

PAC14436SC
OW: 144"
OD: 36"



PAC15636SC
OW: 156"
OD: 36"

Pache Dining Height Table with a Soft Rectangle top

Standard Features:

- 1" Laminate faced MDF core top with a clear edge profile
- 1" Laminate faced plywood core top with a clear finish exposed edge detail
- Solid ash legs with a clear finish
- Aluminum framework available in Black powder coat
- Plastic glides

Optional Features:

- Table edge profile can be stained
- Aluminum framework available in a selection of powder coat finishes
- Solid Ash legs available in Black color wash

Frame Finishes:

- White
- Black
- Stone

Edge Stains:

- Plywood Clear
- Clear
- Solid Black
- Solid White
- Espresso

Wood Finish:

- Clear on Ash

Color Wash based on Ash:

- Back to Black

For larger swatches go to pg.188-205

16 optional Global Laminates are also available please go to pg.196 to see more.

↓ Scan here to discover more



↓ Scan here to discover more





Silta High Level Table

Standard Features:

- 0.75" Laminate faced Plywood core top with a clear finish, exposed edge detail
- 0.75" Linoleum faced Plywood core top with a clear finish, exposed edge detail, available in a selection of colors
- 0.5" Solid surface top available in Cloud
- Solid Ash legs with a clear finish
- Tubular Steel framework finished in White powder coat
- Brushed Steel tie bars
- Brushed Aluminum bag hooks (x2)

Optional Features:

- Solid Ash legs can be stained or color washed
- Tubular Steel framework available in a selection of powder coat finishes

Frame Finishes:

- Black 
- White 
- Slate Gray 

Linoleum:

- Charcoal 
- Pewter 
- Mushroom 

Solid Surface Finish:

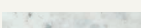
- Cloud 



Edge Stain:

- Plywood Clear 

Wood Finish:

- Ash 

Color Washes based on Ash:

- White as Snow 
- Slate Gray 

For larger swatches go to pg.188-205

6 Wood Stains based on Ash and 16 Global Laminates are also available please go to pg.193 and 196 to see more.

Silta High Level Table with Power

Standard Features:

- 0.75" Laminate faced Plywood core top with a clear finish, exposed edge detail
- 0.75" Linoleum faced Plywood core top with a clear finish, exposed edge detail, available in a selection of colors
- 0.5" Solid surface top available in Cloud
- Solid Ash legs with a clear finish
- Tubular Steel framework finished in White powder coat
- Brushed Steel tie bars
- Brushed Aluminum bag hooks (x2)
- 4 to 12 perimeter power positions (include 1x mains outlet, 2x powered USB) with accessible cable tray

Optional Features:

- Solid Ash legs can be stained or color washed
- Tubular Steel framework available in a selection of powder coat finishes

Frame Finishes:

- Black 
- White 
- Slate Gray 

Linoleum:

- Charcoal 
- Pewter 
- Mushroom 

Solid Surface Finish:

- Cloud 



Edge Stain:

- Plywood Clear 

Wood Finish:

- Ash 

Color Washes based on Ash:

- White as Snow 
- Slate Gray 

For larger swatches go to pg.188-205

6 Wood Stains based on Ash and 16 Global Laminates are also available please go to pg.193 and 196 to see more.

High Level



SLH7236
OW: 72"
OD: 36"

SLH8436
OW: 84"
OD: 36"

SLH9636
OW: 96"
OD: 36"



SLH13636
OW: 136"
OD: 36"

SLH16036
OW: 160"
OD: 36"

SLH18436
OW: 184"
OD: 36"

High Level with Power



SLHP7236 - 4 perimeter power positions
OW: 72"
OD: 36"

SLHP8436 - 6 perimeter power positions
OW: 84"
OD: 36"

SLHP9636 - 6 perimeter power positions
OW: 96"
OD: 36"



SLHP13636 - 8 perimeter power positions
OW: 136"
OD: 36"

SLHP16036 - 12 perimeter power positions
OW: 160"
OD: 36"

SLHP18436 - 12 perimeter power positions
OW: 184"
OD: 36"

↓ Scan here to discover more



Sunda 1

Design by Allermuir Design Studio

158

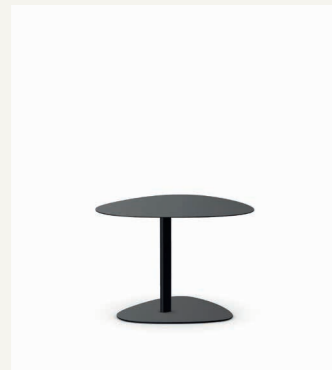

Sunda 1 Low level table



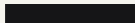
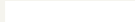

Standard Features:

- Fabricated sheet and tubular Steel construction available in a selection of powder coat finishes
- Plastic glides

Frame Finishes:

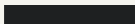
- Black (Textured) 
- White (Textured) 

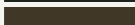
Mineral Finishes:

- Mineral Night 
- Mineral Forest 
- Mineral Clay 
- Mineral Sand 
- Mineral Stone 

For larger swatches go to pg.188-205

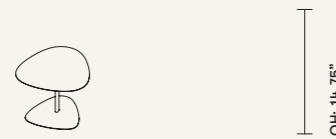

OH: 14.75"

SUN101 - Soft Triangle
OW: 20.75"
OD: 20"

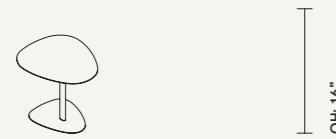

OH: 16"

SUN102 - Soft Triangle
OW: 19"
OD: 16.75"

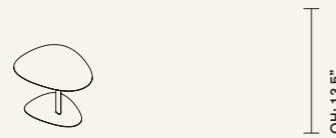

OH: 13.5"

SUN103 - Soft Triangle
OW: 21.75"
OD: 18"

Sunda 2

Design by Allermuir Design Studio

159



Sunda 2 Low level table



Standard Features:

- Reformed Oak veneer face tops on 1" MDF with a cutback, clear finish edge profile
- Tubular Steel frame available in all selection of powder coat finishes
- Plastic glides

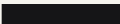

Optional Features:

- Oak veneer tops can be stained or color washed

Frame Finishes:

- Black (Textured) 
- White (Textured) 

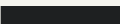
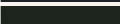
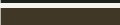
Mineral Finishes:

- Mineral Night 
- Mineral Forest 
- Mineral Clay 
- Mineral Sand 
- Mineral Stone 

Veneer:

- Clear on Oak 

Wood Stains based on Oak:

- Clear 
- White Oak 
- American Cherry 
- American Walnut 
- Dark Walnut 
- Wenge 

For larger swatches go to pg.188-205

16 optional standard color washes based on Oak are also available please go to pg. 193 to see more.

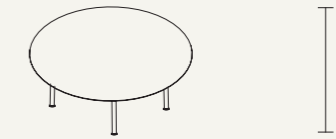

OH: 11.25"

SUN201 - Round
Dia: 39.5"

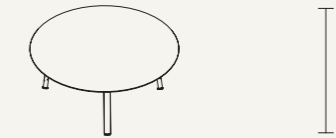

OH: 12.5"

SUN202 - Round
Dia: 31.5"



OH: 13.5"

SUN203 - Round
Dia: 23.75"



OH: 14.75"

SUN204 - Round
Dia: 15.75"

↓ Scan here to discover more



↓ Scan here to discover more



Tibo

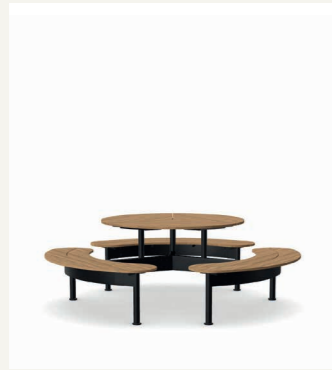

Round Indoor Table



OH: 29"

TORDI
(Suitable for up to six people)

TW: 49"
TD: 49"
OW: 88"
OD: 88"
OH: 29"
SH: 17.5"

Outdoor also available: TORD

Mid Oblong Indoor Table

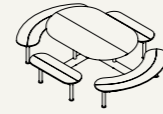

OH: 29"

TOMOI
(Suitable for up to eight people)

TW: 65.5"
TD: 43.5"
OW: 104"
OD: 82"
OH: 29"
SH: 17.5"

Outdoor also available: TOMO

Large Oblong Indoor Table

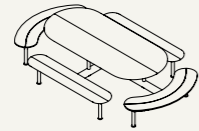

OH: 29"

TOLOI
(Suitable for up to twelve people)

TW: 94.5"
TD: 43.5"
OW: 133"
OD: 82"
OH: 29"
SH: 17.5"

Outdoor also available: TOLO

Tibo Indoor Bench and Table

Standard Features:

- 0.7" Table top and seats in Laminate faced Ply with clear edge
- 0.7" Table top and seats in Laminate faced MDF with contrast edge tape in Ply, Oak, Beech, White or Black
- Cast Aluminum and extruded Aluminum frame in Black (Textured) or Ceramic White powder coat
- Color matched stainless steel leveling feet with Nylon pad



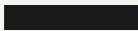

Optional Features:

- 0.7" Table top and seats in Teak (available on outdoor tables only see page 171)
- 0.7" Table top and seats in Charcoal solid core laminate (available on outdoor tables only see page 171)
- Color matched floor fixing kit

Frame Finishes:

- Black (Textured) 
- Ceramic White 

Edge / Edge Tape Finishes:

- Clear 
- Ply 
- Oak 
- White 
- Black 

Solid Core Laminate:

- Charcoal 

Solid Wood Finish:

- Teak 

For larger swatches go to pg.188-205

16 optional Global Laminates also available please go to pg. 196 to see more.

Design by Mark Gabbertas

160

161

Turo

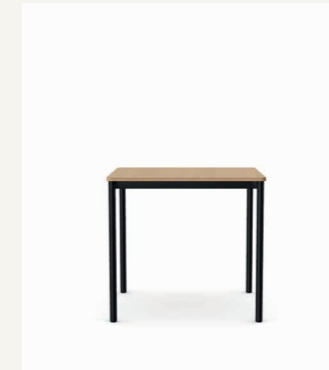

Turo

Standard Features:

- 0.75" Laminate Plywood core top with clear finish edge [Edge 33]
- 0.75" Laminate MDF core top with contrasting edge tape
- Aluminum fluted legs and Steel frame under structure available in Black powder coat
- Integral leg feet with leveling adjustment



Optional Features:

- MDF core top available with contrasting edge tape in Oak, White, Black or Ply
- Aluminum Fluted legs and Steel frame under structure available in a selection of powder coat finishes

Frame Finishes:

- Black 
- White 
- Pebble 
- Sage 

Edge Stains:

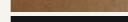
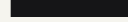
- Plywood Clear 
- Clear 
- Solid Black 
- Solid White 

Edge Tapes:

- Ply 
- Oak 
- White 
- Black 

For larger swatches go to pg.188-205

16 optional Global Laminates also available please go to pg. 196 to see more.

Design by Allermuir Design Studio

Dining - Round



OH: 29"

TRT42RD
Dia: 42"



OH: 29"

TRT48RD
Dia: 48"

Dining - Square



OH: 29"

TRT36SQ
OW: 36"
OD: 36"



OH: 29"

TRT42SQ
OW: 42"
OD: 42"

Dining - Rectangular



OH: 29"

TRT5430RC
OW: 54"
OD: 30"



OH: 29"

TRT6030RC
OW: 60"
OD: 30"



OH: 29"

TRT7236RC
OW: 72"
OD: 36"



OH: 29"

TRT7836RC
OW: 78"
OD: 36"

↓ Scan here to discover more



↓ Scan here to discover more



Contents

- 166 Axyl Outdoor
- 170 Crop Outdoor
- 171 Tibo Outdoor

Outdoor

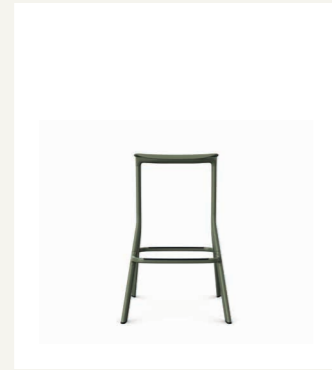
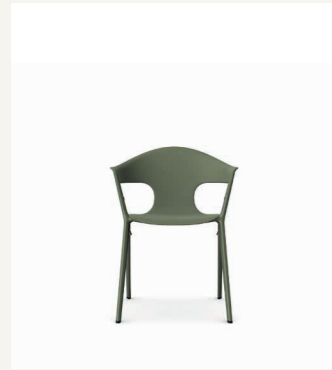

Axyl - AXL52OD Arm chair

Dimensions:

Seat Height	17.75"
Seat Width	16.25"
Seat Depth	17.25"
Overall Height	30.75"
Overall Width	23.75"
Overall Depth	22.25"



Standard Features:

- Plastic shell finished in Black
- Cast Aluminum frame finished in Black (Textured) powder coat
- Stacking buffers
- Plastic glides
- Stacks up to 4 high

Optional Features:

- Plastic shell with complementary Aluminum powder coat frame available in a selection of colors

Frame and Shell Finishes:

Black (Textured)	
Basalt (Textured)	
Sage (Textured)	

For larger swatches go to pg.188-205

Axyl - AXL54OD High stool

Dimensions:

Seat Height	29.5"
Seat Width	5.75"
Seat Depth	15.75"
Overall Height	29.5"
Overall Width	19.5"
Overall Depth	18.5"



Standard Features:

- Plastic seat finished in Black
- Cast Aluminum frame finished in Black (Textured) powder coat
- Integral Plastic footrest protectors
- Plastic glides

Optional Features:

- Plastic seat with complementary Aluminum powder coat frame available in a selection of colors

Frame and Shell Finishes:

Black (Textured)	
Basalt (Textured)	
Sage (Textured)	

For larger swatches go to pg.188-205



Axyl Bistro height



Dimensions:

Overall Height	40"
----------------	-----

Standard Features:

- 0.5" table top in charcoal solid core Laminate
- Cast Aluminum base and Aluminum center column finished in Black (Textured) powder coat
- Integral leg feet with leveling adjustment

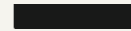
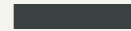
Frame Finishes:

Black (Textured)	
Basalt (Textured)	
Sage (Textured)	
Ivory	

Solid Core Laminates:

Gray	
White	
Charcoal	

For larger swatches go to pg.188-205

Bistro height

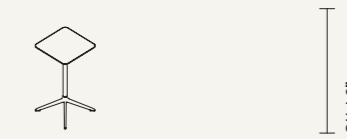

AXLH24SQ-OD
OW: 24"
OD: 24"

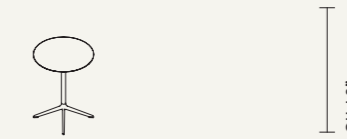

AXLH30RD-OD
Dia: 30"



AXLH30SQ-OD
OW: 30"
OD: 30"

↓ Scan here to discover more



↓ Scan here to discover more



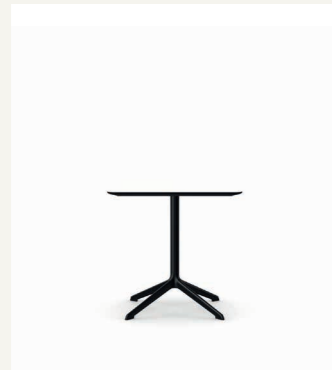

Bistro Dining Height

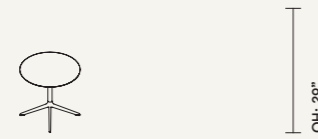

AXLD30RD-OD
Dia: 30"

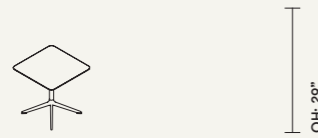

AXLD30SQ-OD
OW: 30"
OD: 30"

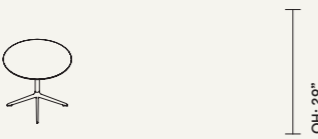

AXLD36RD-OD
Dia: 36"

Axyl Bistro Dining Height

Dimensions:
Overall Height 29"

- Standard Features:
- 0.5" table top in charcoal in solid core laminate
 - Cast Aluminum base and Aluminum center column finished in Black (Textured) powder coat
 - Integral leg feet with leveling adjustment

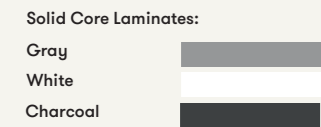
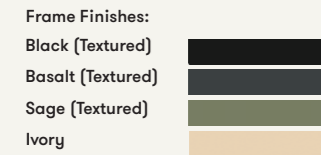

For larger swatches go to pg.188-205

↓ Scan here to discover more



Dining - Rectangular



4XLR6030-OD
OW: 60"
OD: 30"

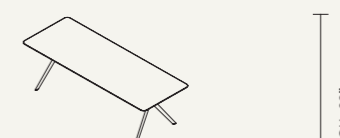

AXL7836-OD
OW: 78"
OD: 36"

Axyl Dining height table with rectangular top

Dimensions:
Overall Height 29"

- Standard Features:
- 0.5" table top in charcoal solid core laminate
 - Cast Aluminum base and Aluminum center column finished in Black (Textured) powder coat
 - Integral leg feet with leveling adjustment

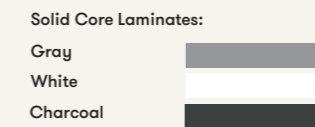
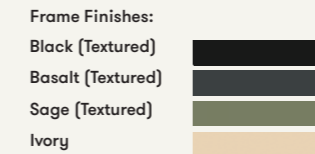

For larger swatches go to pg.188-205

↓ Scan here to discover more



Crop Outdoor

Design by Benjamin Hubert | Layer

170

171

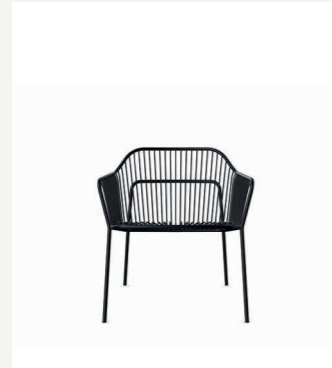
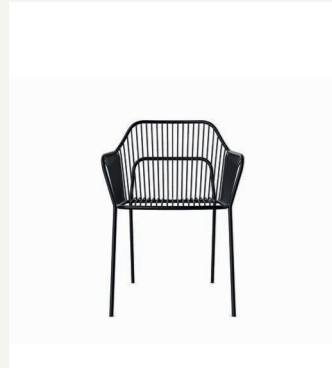

Crop - CRP02 Armchair

Dimensions:

Seat Height	19"
Seat Width	19.25"
Seat Depth	17.25"
Overall Height	32.75"
Overall Width	24.5"
Overall Depth	21.5"
Arm Height	26.75"

Standard Features:

- Steel wire frame finished in Black (Textured) powder coat for outdoor use
- Plastic stacking buffers
- Plastic glides
- Stacks up to 4 high

Optional Features:

- Steel wire frame available in a selection of powder coat finishes

Frame Finishes:

Black (Textured)	
Teal	
Blush	
Ivory	
Pastel Green	
Olive	

Seat Pad Upholstery:

Kvadrat Patio 170	
Kvadrat Patio 230	
Kvadrat Patio 340	
Kvadrat Patio 740	
Kvadrat Patio 840	
Agua Aura Ebony	
Agua Aura Turquoise	
Agua Aura Copper	
Agua Aura Forest	
Agua Aura Mink	
Agua Aura Nimbus	

For larger swatches go to pg.188-205



Crop - CRP03 Lounge chair

Dimensions:

Seat Height	16.5"
Seat Width	20"
Seat Depth	19.25"
Overall Height	28.75"
Overall Width	26.5"
Overall Depth	26.5"
Arm Height	23.75"

Standard Features:

- Steel wire frame finished in Black (Textured) powder coat for outdoor use
- Plastic glides

Optional Features:

- Steel wire frame available in a selection of powder coat finishes

Frame Finishes:

Black (Textured)	
Teal	
Blush	
Ivory	
Pastel Green	
Olive	

Seat Pad Upholstery:

Kvadrat Patio 170	
Kvadrat Patio 230	
Kvadrat Patio 340	
Kvadrat Patio 740	
Kvadrat Patio 840	
Agua Aura Ebony	
Agua Aura Turquoise	
Agua Aura Copper	
Agua Aura Forest	
Agua Aura Mink	
Agua Aura Nimbus	

For larger swatches go to pg.188-205



Crop - CRP05 High back stool

Dimensions:

Seat Height	30.75"
Seat Width	16.75"
Seat Depth	15.25"
Overall Height	40"
Overall Width	18.75"
Overall Depth	20"

Standard Features:

- Steel wire frame finished in Black (Textured) powder coat for outdoor use
- Plastic glides

Optional Features:

- Steel wire frame available in a selection of powder coat finishes
- Counter height stool option, seat height 24.5" (add CH to product code)

Frame Finishes:

Black (Textured)	
Teal	
Blush	
Ivory	
Pastel Green	
Olive	

Seat Pad Upholstery:

Kvadrat Patio 170	
Kvadrat Patio 230	
Kvadrat Patio 340	
Kvadrat Patio 740	
Kvadrat Patio 840	
Agua Aura Ebony	
Agua Aura Turquoise	
Agua Aura Copper	
Agua Aura Forest	
Agua Aura Mink	
Agua Aura Nimbus	

For larger swatches go to pg.188-205



Tibo Outdoor

Design by Allermuir Design Studio

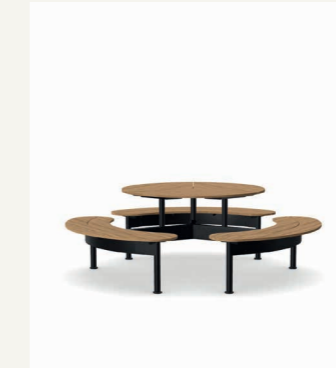

Tibo

Standard Features:

- 0.75" Table top and seats in Teak
- 0.75" Table top and seats in charcoal compact laminate
- Cast aluminum and extruded Aluminum frame in Black (Textured) or Ceramic White powder coat
- Color matched stainless steel leveling feet with Nylon pad
- Color matched floor fixing kit

Frame Finishes:

Black (Textured)	
Ceramic White	

Solid Core Laminate:

Charcoal	
----------	--

Solid Wood Finish:

Teak	
------	--

For larger swatches go to pg.188-205

Round Outdoor Table



TORD
(Suitable for up to six people)

TW: 48"
TD: 48"
OW: 87.7"
OD: 87.7"
OH: 29.1"
SH: 17.6"

Mid Oblong Outdoor Table

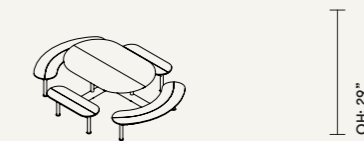

TOMO
(Suitable for up to eight people)

TW: 65.4"
TD: 43.3"
OW: 104"
OD: 81.9"
OH: 29"
SH: 17.6"

Large Oblong Outdoor Table

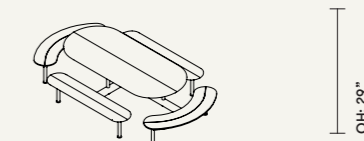

TOLO
(Suitable for up to twelve people)

TW: 94.5"
TD: 43.5"
OW: 133"
OD: 81.9"
OH: 29.1"
SH: 17.6"

↓ Scan here to discover more



↓ Scan here to discover more



Contents

- 174 Crate Divide
- 182 Crate
- 183 Crate Caddy
- 184 Furow
- 185 Mozaik Storage

172

173

Storage

Crate Divide

Design by Allermuir Design Studio

174

175

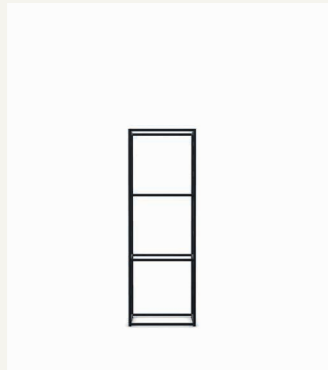

Floor Standing Inline Steel End Ladders

CRT2HE OW: 18" OD: 5/8"	CRT3HE OW: 18" OD: 5/8"	CRT4HE OW: 18" OD: 5/8"	CRT5HE OW: 18" OD: 5/8"
2 High End Ladder with tapped holes on one face	3 High End Ladder with tapped holes on one face	4 High End Ladder with tapped holes on one face	5 High End Ladder with tapped holes on one face

Floor Standing Inline Steel Mid Ladders

CRT2HM OW: 18" OD: 5/8"	CRT3HM OW: 18" OD: 5/8"	CRT4HM OW: 18" OD: 5/8"	CRT5HM OW: 18" OD: 5/8"
2 High Mid Ladder with tapped holes on both front and back faces	3 High Mid Ladder with tapped holes on both front and back faces	4 High Mid Ladder with tapped holes on both front and back faces	5 High Mid Ladder with tapped holes on both front and back faces

Floor Standing L-Corner End Frames

CRT2H90-KD OW: 458mm / 18" OD: 458mm / 18"	CRT3H90-KD OW: 458mm / 18" OD: 458mm / 18"	CRT4H90-KD OW: 458mm / 18" OD: 458mm / 18"	CRT5H90-KD OW: 458mm / 18" OD: 458mm / 18"
2 High L-Corner End Frame	3 High L-Corner End Frame	4 High L-Corner End Frame	5 High L-Corner End Frame
Welded corner frame with tapped holes on two sides	Welded corner frame with tapped holes on two sides	Welded corner frame with tapped holes on two sides	Welded corner frame with tapped holes on two sides

Floor Standing T-Corner End Frames

CRT2H180-KD OW: 18" OD: 18"	CRT3H180-KD OW: 18" OD: 18"	CRT4H180-KD OW: 18" OD: 18"	CRT5H180-KD OW: 18" OD: 18"
2 High T-Corner End Frame	3 High T-Corner End Frame	4 High T-Corner End Frame	5 High T-Corner End Frame
Welded corner frame with tapped holes on three sides	Welded corner frame with tapped holes on three sides	Welded corner frame with tapped holes on three sides	Welded corner frame with tapped holes on three sides

Crate Divide

- Standard Features:**
- Tubular Steel frame finished in Black powder coat
 - Plastic glides with leveling adjustment

- Optional Features:**
- Tubular Steel frame available in a selection of colors

Frame Finishes:

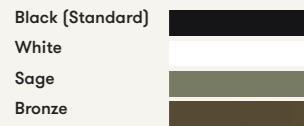

For larger swatches go to pg.188-205

Crate Divide

Design by Allermuir Design Studio



Connector Bar Packs

CRT6CB-KD - Single Fixing Kit	CRT8CB-KD - Single Fixing Kit
<ul style="list-style-type: none"> — 6x Connector bars — 12x Connector Castings — 12x M5x10 CSK bolts — 12x M4x10 CAP bolts — 1 Wall Bracket, 4 Spacers — 2 Floor Hooks 	<ul style="list-style-type: none"> — 8x Connector bars — 16x Connector Castings — 16x M5x10 CSK bolts — 16x M4x10 CAP bolts — 1 Wall Bracket, 4 Spacers — 2 Floor Hooks

Crate Divide

- Standard Features:**
- Tubular Steel frame finished in Black powder coat
 - Floor and wall fixing brackets (Single connector bar packs only)

- Optional Features:**
- Tubular Steel frame available in a selection of colors

Frame Finishes:

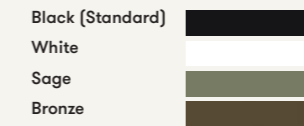

For larger swatches go to pg.188-205

Double Connector Bar Packs

CRT2DCB-KD	CRT4DCB-KD
<ul style="list-style-type: none"> — 2x Double connector bars — 4x Connector Castings — 4x M5x10 CSK bolts — 4x M4x10 CAP bolts 	<ul style="list-style-type: none"> — 4x Double connector bars — 8x Connector Castings — 8x M5x10 CSK bolts — 8x M4x10 CAP bolts
CRT6DCB-KD	
<ul style="list-style-type: none"> — 6x Double connector bars — 12x Connector Castings — 12x M5x10 CSK bolts — 12x M4x10 CAP bolts 	

↓ Scan here to discover more



↓ Scan here to discover more



Crate Divide

Design by Allermuir Design Studio

176

177

Crate Divide

Design by Allermuir Design Studio

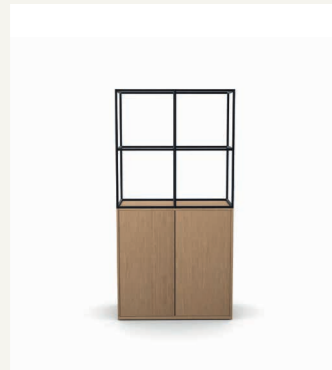

Bay Storage

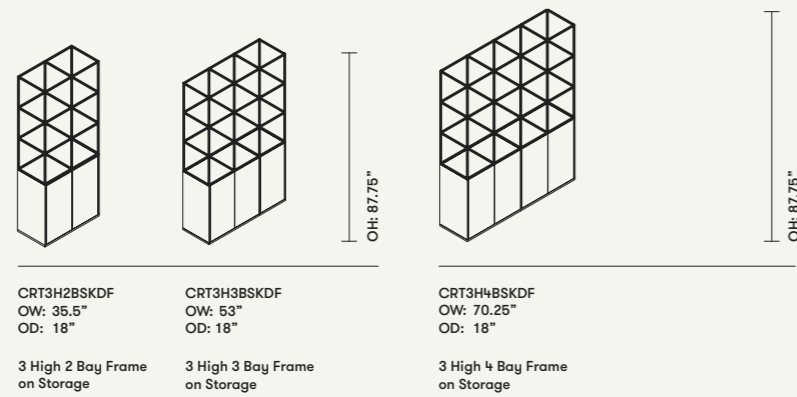
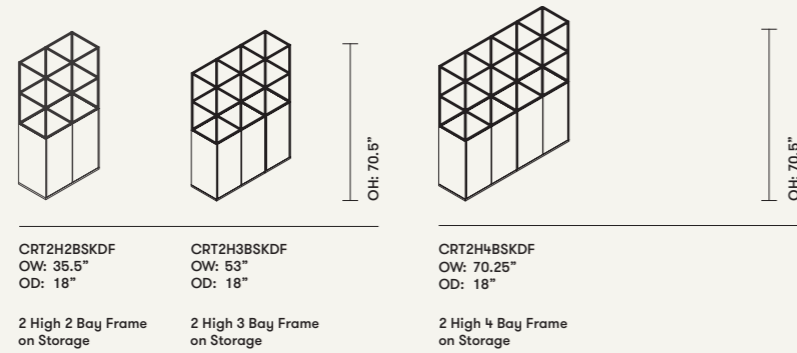

Cubby Storage

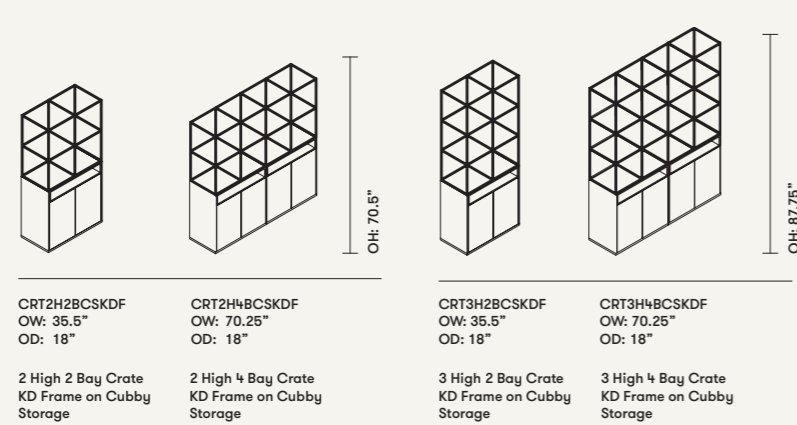

Crate Divide

Standard Features:

- Tubular Steel frame finished in Black powder coat
- TFL Storage available in Black, White, Strata Oak or Urban Maple
- TFL Cubby available in complementary Black, White, Strata Oak or Urban Maple
- Plastic glides with leveling adjustment

Optional Features:

- Tubular Steel frame available in a selection of colors
- Storage and accessories available on pg.180

Frame Finishes:

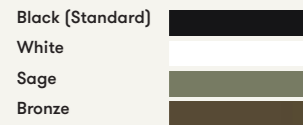

TFL Finishes:

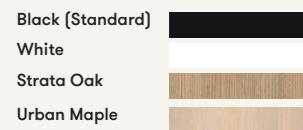

For larger swatches go to pg.188-205

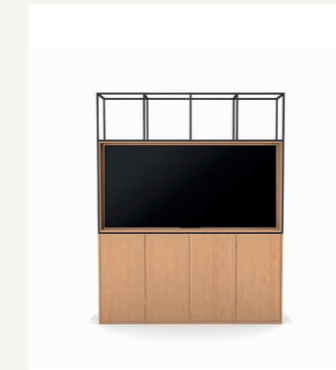

Media Unit

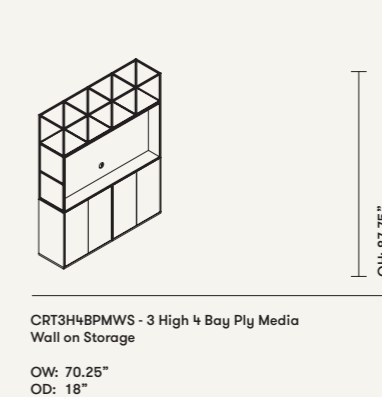

Crate Divide Media Wall on Storage

Standard Features:

- Tubular Steel frame finished in Black powder coat
- TFL Lower Storage available in Black, White, Strata Oak or Urban Maple
- TFL Media Wall Box available in Black, White, Strata Oak or Urban Maple
- Ply Media Wall Box available in Ply with a clear lacquered finish (CRT3H4BPMWS)
- Plastic glides with leveling adjustment
- Pinnable fabric back panel available in Camira Blazer or Synergy

Optional Features:

- Tubular Steel frame available in a selection of colors

Frame Finishes:

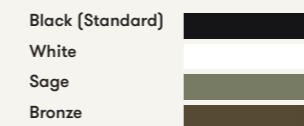

TFL Finishes:

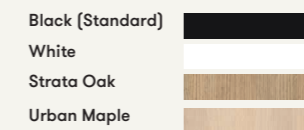

Ply Finish:

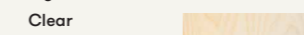

For larger swatches go to pg.188-205

↓ Scan here to discover more



↓ Scan here to discover more



Crate Divide

Design by Allermuir Design Studio

178

179

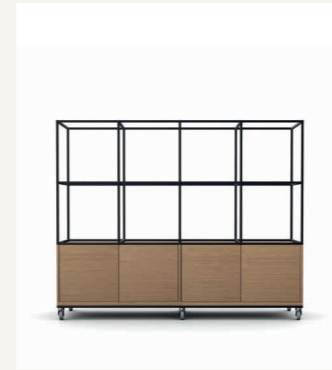
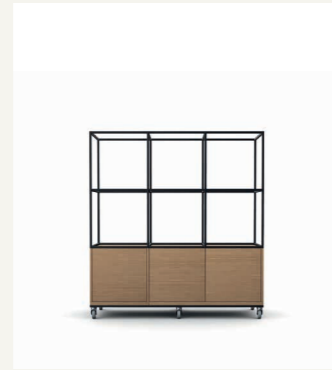
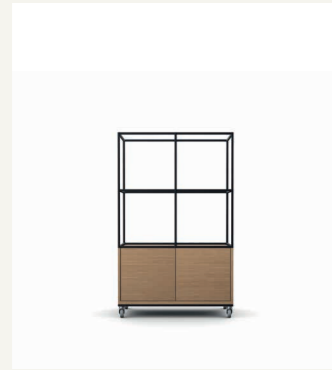

Crate Divide - CRT2H2BMSKDF 2 High 2 Bay on Mobile Storage

Dimensions:
Overall Height 57"
Overall Width 35.5"
Overall Depth 18"

- Standard Features:
- Tubular Steel frame finished in Black powder coat
 - TFL Storage available in Black, White, Strata Oak or Urban Maple
 - Metal casters with wheel brakes

- Optional Features:
- Tubular Steel frame available in a selection of colors
 - Storage and accessories available on pg.180

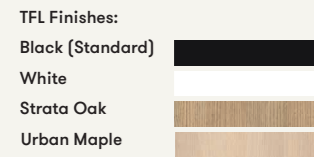
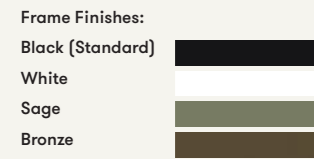

For larger swatches go to pg.188-205

Crate Divide - CRT2H3BMSKDF 2 High 3 Bay on Mobile Storage

Dimensions:
Overall Height 57"
Overall Width 53"
Overall Depth 18"

- Standard Features:
- Tubular Steel frame finished in Black powder coat
 - TFL Storage available in Black, White, Strata Oak or Urban Maple
 - Metal casters with wheel brakes

- Optional Features:
- Tubular Steel frame available in a selection of colors
 - Storage and accessories available on pg.180

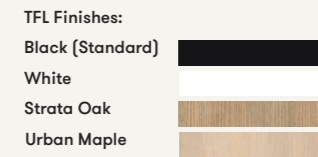
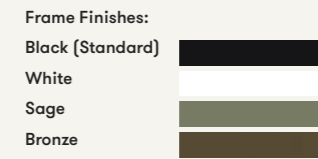

For larger swatches go to pg.188-205

Crate Divide - CRT2H4BMSKDF 2 High 4 Bay on Mobile Storage

Dimensions:
Overall Height 57"
Overall Width 70.25"
Overall Depth 18"

- Standard Features:
- Tubular Steel frame finished in Black powder coat
 - TFL Storage available in Black, White, Strata Oak or Urban Maple
 - Metal casters with wheel brakes

- Optional Features:
- Tubular Steel frame available in a selection of colors
 - Storage and accessories available on pg.180

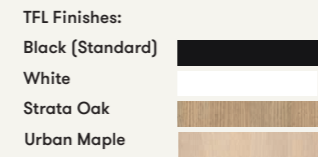
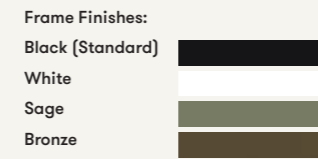

For larger swatches go to pg.188-205

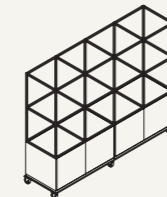
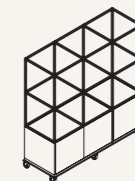

↓ Scan here to discover more



↓ Scan here to discover more



Crate Divide

Design by Allermuir Design Studio

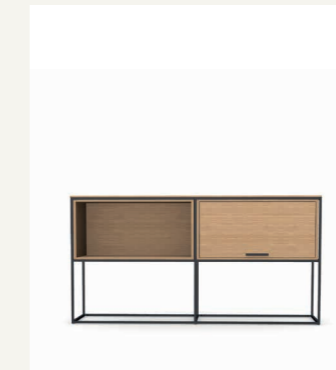

Low Credenza

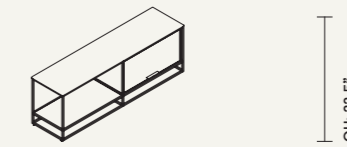

CRTLCDMSFD
OW: 70.25"
OD: 18"

Low Credenza with TFL Shelf and Flipper Door storage unit. Also available in Ply: CRTLCDPSFD

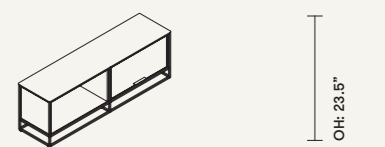

CRTLCDMCBFD
OW: 70.25"
OD: 18"

Low Credenza with TFL Closed Box and Flipper Door storage unit. Also available in Ply: CRTLCDPCBFD

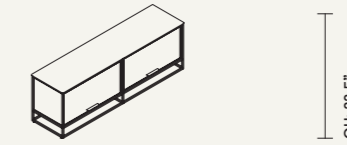

CRTLCDM2FD
OW: 70.25"
OD: 18"

Low Credenza with 2 TFL Flipper Door Storage units. Also available in Ply: CRTLCDP2FD

Crate Divide Credenza

- Standard Features:
- Tubular Steel frame finished in Black powder coat
 - TFL storage available in Black, White, Strata Oak or Urban Maple
 - Ply Storage available in clear lacquer finish
 - 0.75" Solid surface top available in Cloud

- Optional Features:
- Tubular Steel frame available in a selection of colors
 - Storage and accessories available on pg.180

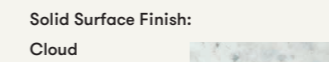
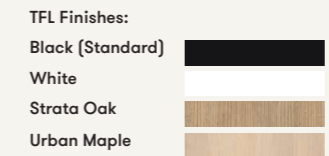
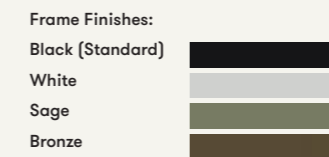

For larger swatches go to pg.188-205

High Credenza

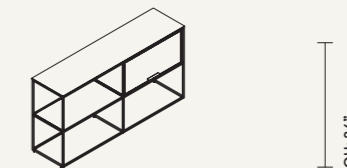

CRTHCDMSFD
OW: 70.25"
OD: 18"

High Credenza with TFL Shelf and Flipper Door storage unit. Also available in Ply: CRTHCDPSFD

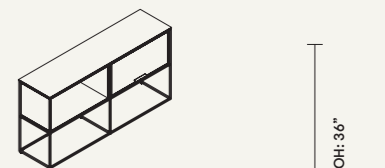

CRTHCDMCBFD
OW: 70.25"
OD: 18"

High Credenza with TFL Closed Box and Flipper Door storage unit. Also available in Ply: CRTHCDPCBFD

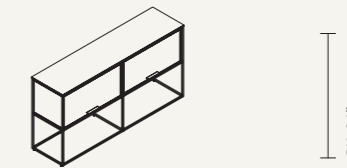

CRTHCDM2FD
OW: 70.25"
OD: 18"

High Credenza with 2 TFL Flipper Door Storage units. Also available in Ply: CRTHCDP2FD

Crate Divide

Design by Allermuir Design Studio

180

181

Storage & Accessories

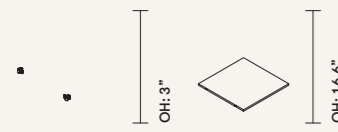

CRTLK - 2 Linking Brackets

OW: 0.75"
OD: 0.7"

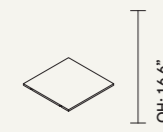

CRTPS - Ply shelf

OW: 16.6"
OD: 0.5"

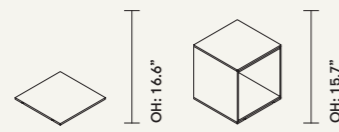

CRTMS - TFL shelf

OW: 16.6"
OD: 0.5"

CRTPOB - Ply open box

OW: 15.7"
OD: 16.25"

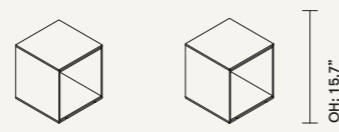

CRTMOB - TFL open box

OW: 15.7"
OD: 16.25"

CRTPCB - Ply closed box

OW: 15.7"
OD: 16.25"

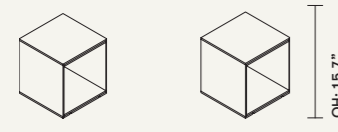

CRTMCB - TFL closed box

OW: 398mm / 15.7"
OD: 410mm / 16.25"

CRTBPB - Ply box with plastic back

OW: 398mm / 15.7"
OD: 406mm / 16"

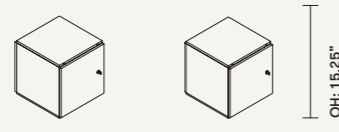

CRTPLB - Ply Locker

OW: 387mm / 15.25"
OD: 420mm / 16.5"

CRTMLB - TFL Locker

OW: 387mm / 15.25"
OD: 420mm / 16.5"

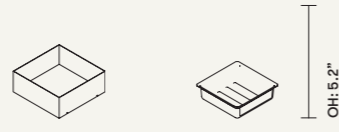

CRTSPT - Steel planter tray

OW: 16.5"
OD: 16.5"

CRTPPT - Plastic planter tray

OW: 16.5"
OD: 16.5"

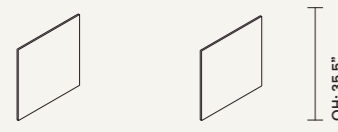

CRTMP - Magnetic dry wipe back panel

OW: 35.5"

CRTPPF - Pinnable fabric back panel

OW: 35.5"

Available in Camira Blazer or Synergy Fabric Finish

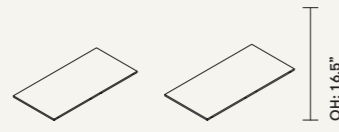

CRT2BPS - 2 Bay Ply Shelf

OW: 3 1/4"
OD: 0.5"

CRT2BMS - 2 Bay TFL Shelf

OW: 3 1/4"
OD: 0.5"

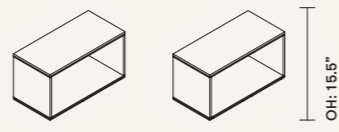

CRT2BPOB - 2 Bay Ply Open Box

OW: 33"
OD: 16.5"

CRT2BMOB - 2 Bay TFL Open Box

OW: 33"
OD: 16.5"

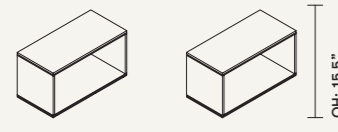

CCRT2BPCB - 2 Bay Ply Closed Box

OW: 33"
OD: 16.25"

CRT2BMCB - 2 Bay TFL Closed Box

OW: 33"
OD: 16.25"

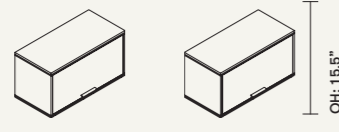

CRT2BPFDB - 2 Bay Ply Box with Flipper Door

OW: 33"
OD: 15.5"

CRT2BMFDB - 2 Bay TFL Box with Flipper Door

OW: 33"
OD: 15.5"

Crate Divide - Configurations:

Create your own using our product configurator at allermuir.com

Example 1

2x CRT5HE
1x CRT3HM
2x CRT8CB-KD
1x CRT4DCB-KD

Left Facing



Forward Facing



Example 2

1x CRT5HE
1x CRT3HE
1x CRT3HM
1x CRT5HM
2x CRT2HM
1x CRT4HM
4x CRT12CB-KD
2x CRT4DCB-KD
1x CRT2DCB-KD
1x CRT5H90-KD

Left Facing

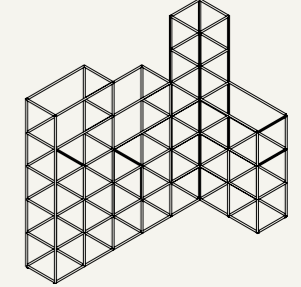

Forward Facing

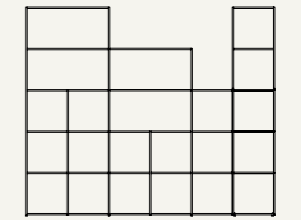

Example 3

1x CRT3H4BMMWS
4x CRT5HE
2x CRT5HM
4x CRT12CB-KD

[Optional linking kits]
2x CRTLK

Left Facing

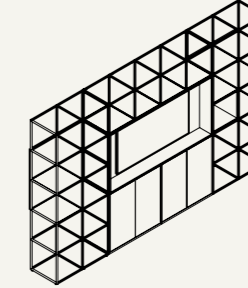

Forward Facing

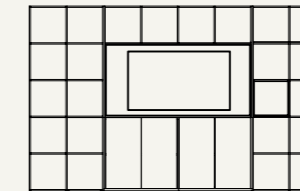

Example 4

1x CRT3H4BMMWS
2x CRT3H2BS-KD
[Optional linking kits]
2x CRTLK

Left Facing

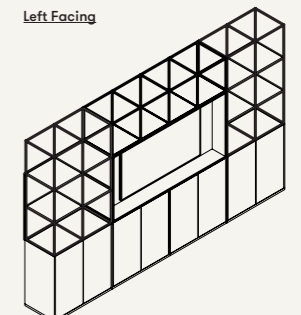

Forward Facing

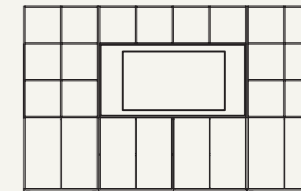

Example 5

1x CRT3HE
1x CRT5HE
1x CRT5H90-KD
5x CRT2HM
1x CRT3HM
3x CRT4HM
3x CRT5HM
7x CRT12CB-KD
1x CRT8CB-KD
4x CRT6DCB-KD

Left Facing

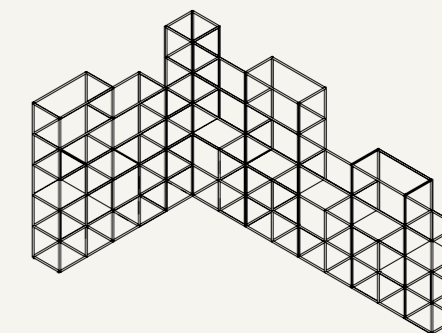

Front Facing

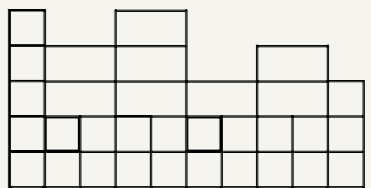

↓ Scan here to discover more



↓ Scan here to discover more



Crate

Design by Allermuir Design Studio

182



Crate — CRT6020 Planter

Dimensions:

Overall Height 24.75"
Overall Width 23.5"
Overall Depth 9.75"

Standard Features:

- Steel frame and box insert finished in Black powder coat
- Solid Oak top shelf with a clear finish
- Plastic glides

Optional Features:

- Steel frame and box insert available in Sage or Pebble powder coat

Frame Finishes:



Solid Wood Finish:

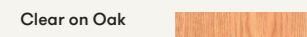

For larger swatches go to pg.188-205



Crate Caddy

Design by Allermuir Design Studio

183

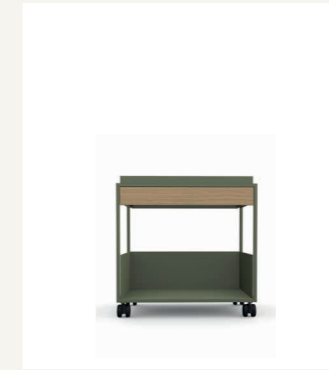

Crate Caddy — CRTCDY Mobile caddy storage unit

Dimensions:

Overall Height 22"
Overall Width 21.5"
Overall Depth 14.5"

Standard Features:

- Tubular Steel frame finished in Black powder coat
- Cork lining on top tray and shelf
- Oak-fronted shelf on steel runners
- Plastic casters

Optional Features:

- Tubular Steel frame available in a selection of colors

Frame Finishes:



For larger swatches go to pg.188-205



↓ Scan here to
discover more



↓ Scan here to
discover more



Furow

Design by Allermuir Design Studio

184

185

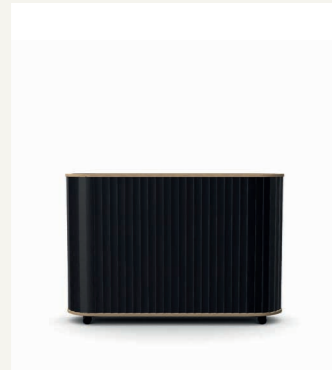

Steel Planter

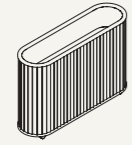

OH: 37.5"

FW4014S
OW: 55"
OD: 15.75"

Timber Planter



OH: 37.5"

FW4014T
OW: 55"
OD: 15.75"

Furow

Standard Features:

- Steel frame finished in Black or White powder coat
- Oak frame with a clear finish on Timber Planter
- Ply panels on Steel Planter with a clear finish
- Matte Black HIPS liner
- Casters with wheel brake

Steel Frame Finishes:

Black 
White 

Oak Frame Finish:

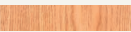
Clear 

For larger swatches go to pg.188-205



OH: 23.5"

FW40RDS
Dia: 15.75"



OH: 23.5"

FW40RDT
Dia: 15.75"

Mozaik Storage

Design by Allermuir Design Studio



OH: 15.5"

MZKLT
OW: 33.75"
OD: 33.75"

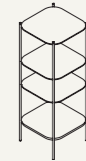

OH: 14.25"

MZKHSS
OW: 17"
OD: 17"

Mozaik Storage



Standard Features:

- Matte Laminate faced MDF core surface available in Matte White or Matte Black
- Edge profile is stained to match the laminate top
- Wire frame finished in Black powder coat
- Plastic glides

Optional Features:

- Wire frame available in White powder coat

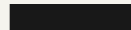
Frame Finishes:

Black 
White 

Matte Laminate faced MDF core surface:

Matte Black 
Matte White 

For larger swatches go to pg.188-205



H: 895mm / 23.5"

MZKLS
OW: 17"
OD: 17"



OH: 23.5"

MZKLS
OW: 33.75"
OD: 17"

↓ Scan here to discover more



↓ Scan here to discover more



Contents

188	Metal / Frame Finishes
190	Plastic / Shell Finishes
191	Solid Surfaces and Marble / Stone Finishes
191	Linoleum
191	Special Finishes - Batan Collection
192	Solid Wood and Veneer Finishes
193	Wood Stains
194	Color Washes
196	Global and Matte Laminates
197	Solid Core Laminates
197	Edge Tapes
197	Kvadrat Really Tops
198	TFL
198	Edge Stains and Edge Details
200	Seat Pad Upholstery
201	Loose Cushion Details
202	Tylus Finishes
204	Outdoor Finishes

* Care has been taken to show all finishes as true as possible however colors shown may vary slightly from the actual product. Finish samples and cards showing actual color and finish are available on request, please speak to your sales representative.

Metal / Frame Finishes

* When ordering finish samples please note Kin, Folk and Folk Tables all use Matte White.



Aubergine Matte Finish
Basalt Matte Finish
Basalt (Textured) FineTex Finish
Black Standard Finish
Black (Textured) FineTex Finish
Blue Skies FineTex Finish



Blush FineTex Finish
Brass Plated Metal Finish
Bronze Standard Finish
Brushed Chrome Metal Finish
Ceramic White FineTex Finish
Coral Matte Finish



Crayon Gray Matte Finish
Dark Bronze Standard Finish
Deep Mulberry FineTex Finish
Forest Green (Textured) FineTex Finish
Haze Blue Matte Finish
Ivory FineTex Finish



Matte Black Matte Finish
Matte White Matte Finish
Mellow Yellow FineTex Finish
Mineral Clay Mineralized Finish
Mineral Forest Mineralized Finish
Mineral Night Mineralized Finish

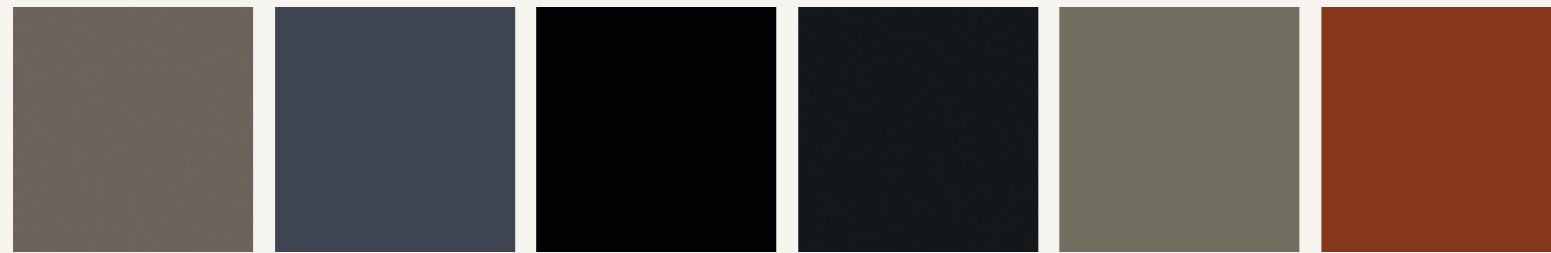

Mineral Sand Mineralized Finish
Mineral Stone Mineralized Finish
New Black Standard Finish
Off Black Matte Finish
Olive FineTex Finish
Orange Crush FineTex Finish

Metal / Frame Finishes



Pastel Green FineTex Finish
Peacock Blue Matte Finish
Pebble Matte Finish
Pistachio Matte Finish
Polished Aluminum Metal Finish
Polished Chrome Metal Finish



Red Matte Finish
Sage Matte Finish
Sage (Textured) FineTex Finish
Seattle Green Matte Finish
Silver MO4 Standard Finish
Slate Gray Standard Finish



Soft Gold FineTex Finish
Soft Silver FineTex Finish
Stone Matte Finish
Teal FineTex Finish
Touch of Gray FineTex Finish
Ultramarine Blue FineTex Finish

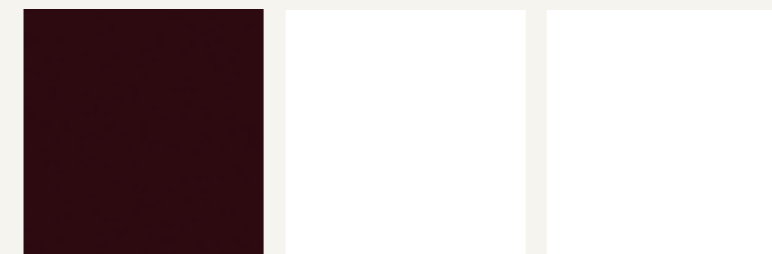

Vintage Red FineTex Finish
White Standard Finish
White (Textured) FineTex Finish

Plastic / Shell Finishes



Aubergine
Plastic / Shell Finish

Basalt
Plastic / Shell Finish

Black / Back to Black
Plastic / Shell Finish

Blue Skies
Plastic / Shell Finish

Coral
Plastic / Shell Finish

Crayon Gray
Plastic / Shell Finish

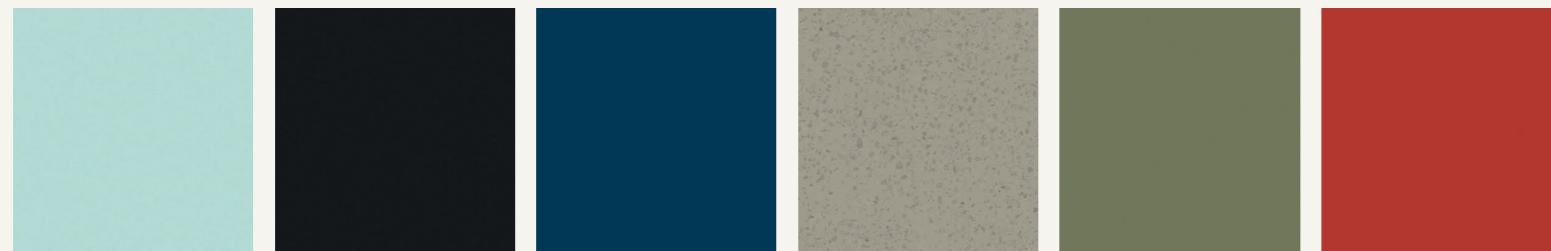

Haze Blue
Plastic / Shell Finish

Off Black
Plastic / Shell Finish

Peacock Blue
Plastic / Shell Finish

Pebble - Wood Fiber
Plastic / Shell Finish

Pistachio
Plastic / Shell Finish

Red
Plastic / Shell Finish

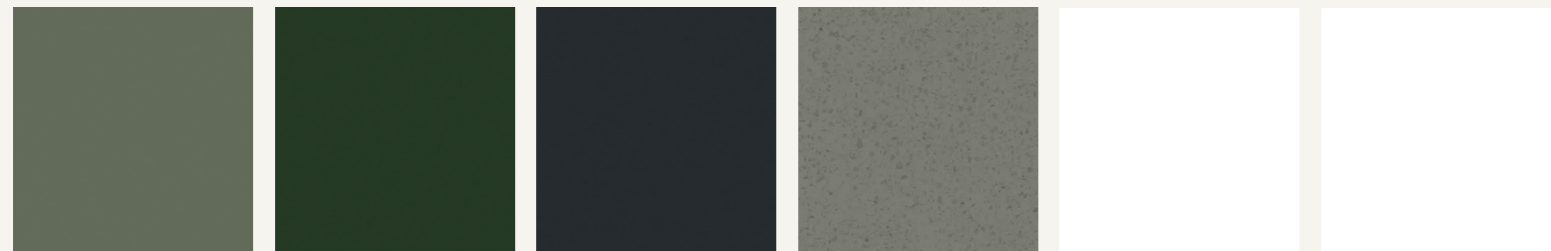

Sage
Plastic / Shell Finish

Seattle Green
Plastic / Shell Finish

Slate Gray
Plastic / Shell Finish

Stone - Wood Fiber
Plastic / Shell Finish

White
Plastic / Shell Finish

White as Snow
Plastic / Shell Finish

PU Shell Finishes

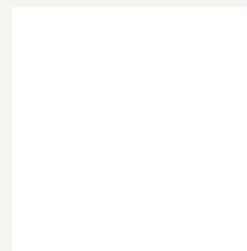

Pure White
PU

Solid Surfaces / Marble / Stone Finishes

* Finishes are not to scale for a representation please order a finish card.

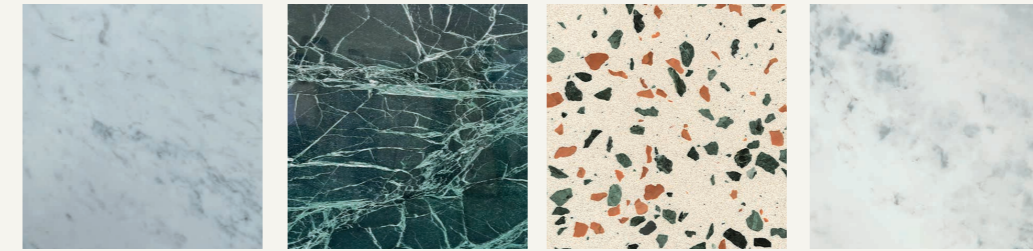

Carrara
Solid Marble Finish

Verde Oriental
Solid Marble Finish

Vendome
Solid Stone Finish

Cloud
Solid Surface

Linoleum

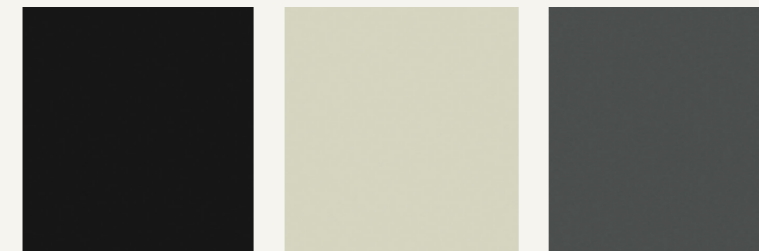

Charcoal
Linoleum

Mushroom
Linoleum

Pewter
Linoleum

Special Finishes

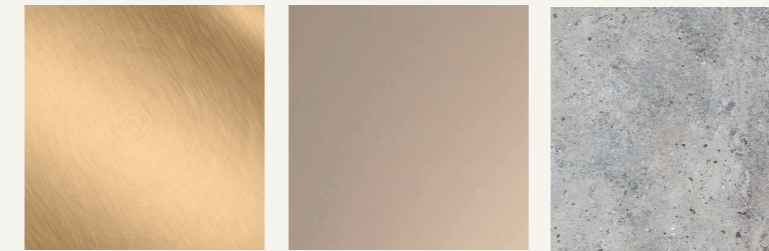

Brass Plated
Top Finish

Frosted Beige Glass
Top Finish

Natural
Concrete Base Finish

Solid Wood Finishes



Ash with Clear Finish Wood Finishes
Beech with Clear Finish Wood Finishes
Oak with Clear Finish Wood Finishes
Ply with Clear Finish Wood Finishes
Teak Wood Finishes

Solid Oak Top Finishes



Oak with Clear Finish Solid Oak Top Finish
Black Oak Top Solid Oak Stain
Blue Oak Top Solid Oak Stain

Veneers



Clear Walnut Veneer
Clear Oak Veneer
Plywood Veneer Frame / Shell Finish
Alpi Veneer

Wood Stains Based on Ash



Clear Based on Ash
White Oak Based on Ash
American Cherry Based on Ash
American Walnut Based on Ash
Dark Walnut Based on Ash
Wenge Based on Ash

Wood Stains Based on Beech



Clear Based on Beech
White Oak Based on Beech
American Cherry Based on Beech
American Walnut Based on Beech
Dark Walnut Based on Beech
Wenge Based on Beech

Wood Stains Based on Oak



Clear Based on Oak
White Oak Based on Oak
American Cherry Based on Oak
American Walnut Based on Oak
Dark Walnut Based on Oak
Wenge Based on Oak

Standard Color Washes



* Colors may vary depending on Solid Wood type (Ash, Beech or Oak)
For a representation of color washes on specific wood finish types, please order a finish card.

Axyl Bench Color Washes



Folk / Kin Color Washes

* Haze Blue and Red color washes apply to Kin only.



Global Laminates



Brite White
Global Laminate

Fog
Global Laminate

Mouse
Global Laminate

Fossil
Global Laminate

Storm
Global Laminate

Sarum Gray
Global Laminate

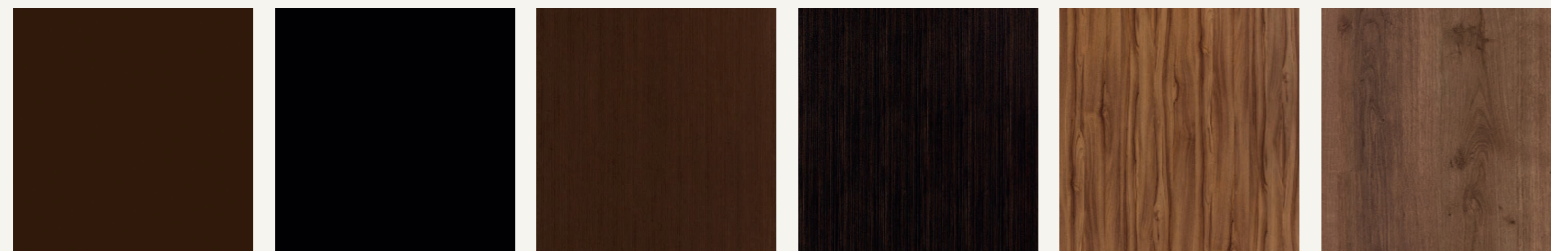

Dark Chocolate
Global Laminate

Diamond Black
Global Laminate

Chestnut Woodline
Global Laminate

Ebony
Global Laminate

Oiled Walnut
Global Laminate

Planked Coffee Oak
Global Laminate



Smoky Brown Pear
Global Laminate

Millennium Oak
Global Laminate

Natural Ash
Global Laminate

White Ash
Global Laminate

Matte Laminates

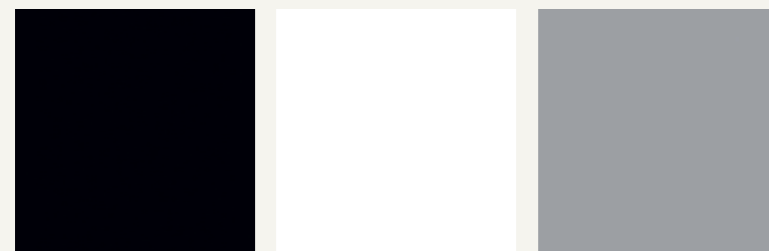

Matte Black
Matte Laminate

Matte White
Matte Laminate

Tusk Gray
Matte Laminate

Edge Tapes



Black
Edge Tape

White
Edge Tape

Oak
Edge Tape

Ply
Edge Tape

Kvadrat Really Top



Cotton Blue
Kvadrat Really Top

Cotton Cream
Kvadrat Really Top

Cotton White
Kvadrat Really Top

Solid Core Laminates

* Core of all Solid Core Laminates is Black.

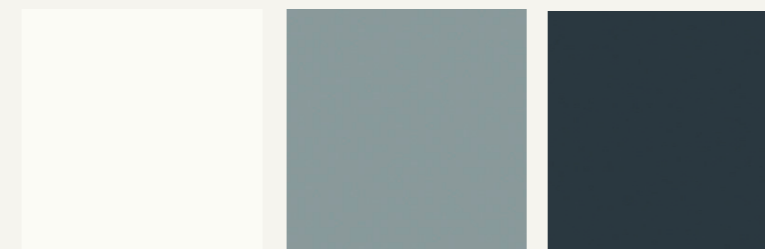

White
Solid Core Laminate

Gray
Solid Core Laminate

Charcoal
Solid Core Laminate

* Only Urban Maple, Strata Oak, Black and White apply to Crate Divide



Black TFL White TFL Strata Oak TFL Urban Maple TFL Autumn TFL Carini Walnut TFL



Highland Oak TFL Winter Oak TFL Clay TFL Denim TFL Light Grey TFL

Edge Stains



Clear on Ply Edge Stains Clear on MDF Edge Stains Solid Black Edge Stain Espresso Edge Stain Solid White Edge Stain

Edge Details



Edge Detail # 11
1" MDF core, specified laminate face and counterbalance with convex edge, as standard. The edge is clear finished as standard or can be stained.

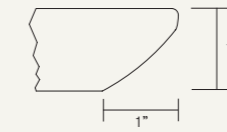

Edge Detail # 28
HPL laminate over a 1" MDF core counter balanced. The edge is cut back with a chamfer. The edge is clear finish as standard or can be stained.

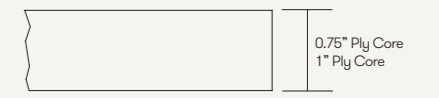

Edge Detail # 33
0.75" ply core, specified laminate or linoleum face and counterbalanced with a flat edge, and clear finish or 1" ply core, specified laminate or linoleum face and counterbalanced with a flat edge, clear finish.

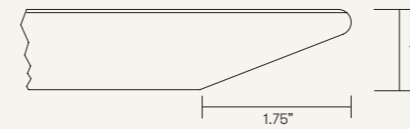

Edge Detail # 37
HPL laminate over a 1" MDF core counter balanced. The edge is cut back with a chamfer. The edge is clear finish as standard or can be stained.

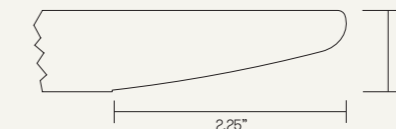

Edge Detail # 38
HPL laminate over a 1" MDF core counter balanced. The edge is cut back with a chamfer. The edge is clear finish as standard or can be stained.



Edge Detail # 41
0.5" solid surface - Design range.

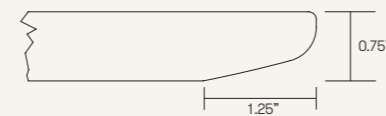

Edge Detail # 43
0.75" solid wood.



Edge Detail # 46
1" MDF core, specified melamine face and counterbalance. The edge is clear finish as standard.

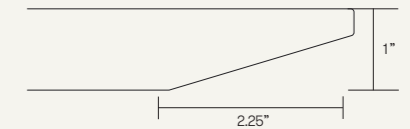

Edge Detail # 47
1" laminate faced MDF core top

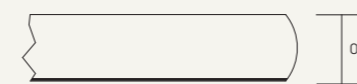

Edge Detail # 56
Profile available in:
0.4" - toughened glass sand blasted Ritek coated on underside Polished edges. Solid core laminate with Polished edge.



Edge Detail # 69
HPL laminate over a 1" MDF core with matching or solid PVC edge.



Edge Detail # 76
HPL laminate face and 3" built down edge.

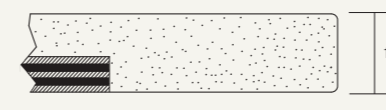

Edge Detail # 80
Solid surface 1" thick backed with hardwood plywood.

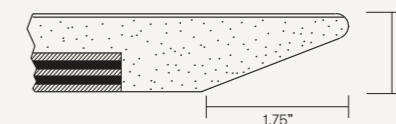

Edge Detail # 82
Solid surface 1" thick backed with hardwood plywood.



Edge Detail # 90
HPL laminate face and 3.5" built down edge.



Ref Group # TE
Taped Edge

Ooty Seat Pad Upholstery



Melange Nap 111
Ooty Seat Pad

Melange Nap 191
Ooty Seat Pad

Melange Nap 211
Ooty Seat Pad

Melange Nap 271
Ooty Seat Pad

Melange Nap 521
Ooty Seat Pad

Melange Nap 711
Ooty Seat Pad



Melange Nap 951
Ooty Seat Pad

Crop Seat Pad Upholstery

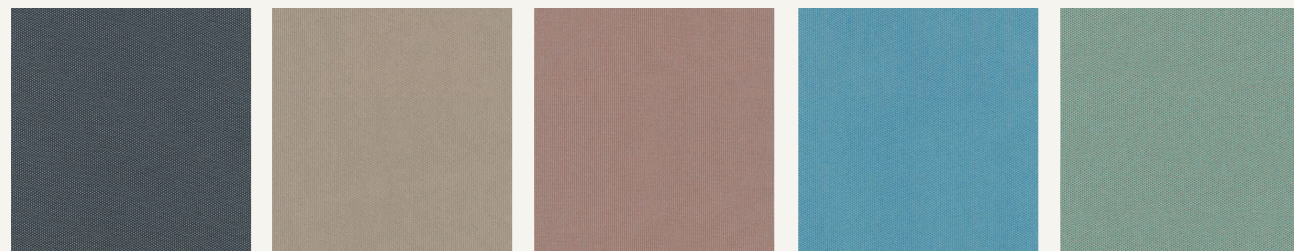

Kvadrat Patio 170
Crop Seat Pad

Kvadrat Patio 230
Crop Seat Pad

Kvadrat Patio 340
Crop Seat Pad

Kvadrat Patio 740
Crop Seat Pad

Kvadrat Patio 840
Crop Seat Pad

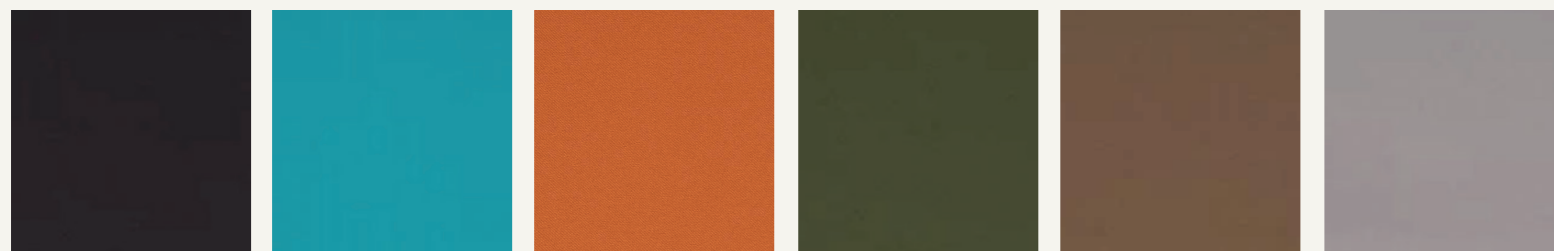

Agua Aura Ebony
Crop Seat Pad

Agua Aura Turquoise
Crop Seat Pad

Agua Aura Copper
Seat Pad Upholstery

Agua Aura Forest
Crop Seat Pad

Agua Aura Mink
Crop Seat Pad

Agua Aura Nimbus
Crop Seat Pad

Loose Cushion Edge Details

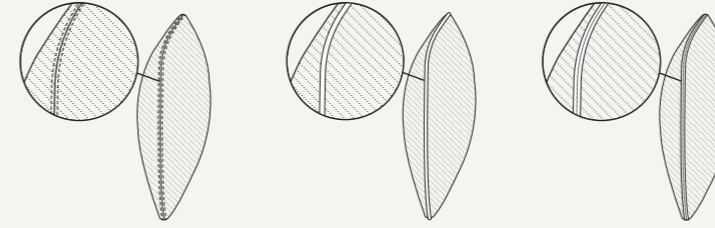

Twinned
Cushion Edge Detail

Piped
Cushion Edge Detail

Zipped
Cushion Edge Detail

Loose Cushion Face Details



Plain
Cushion Face Detail

Single Button
Cushion Face Detail

Multi Button
Cushion Face Detail

Quilted
Cushion Face Detail

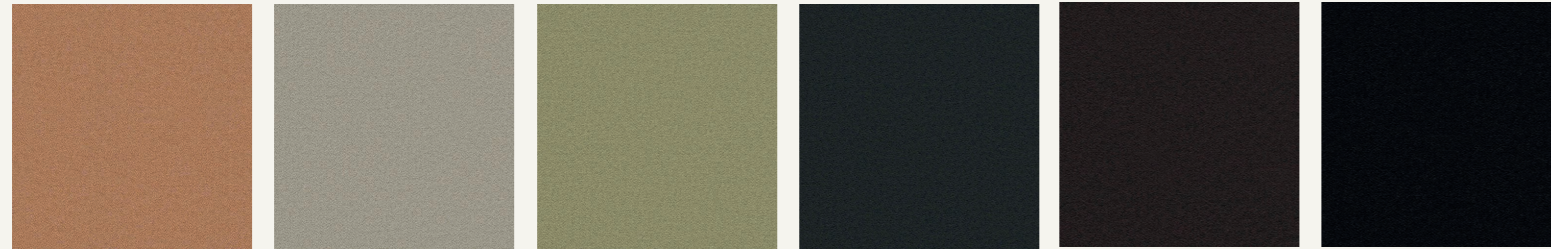

Loop LDS18
Tylus Synergy

Level LDS20
Tylus Synergy

Bracket LDS23
Tylus Synergy

Compound LDS25
Tylus Synergy

Bridge LDS26
Tylus Synergy

Seek LDS27
Tylus Synergy

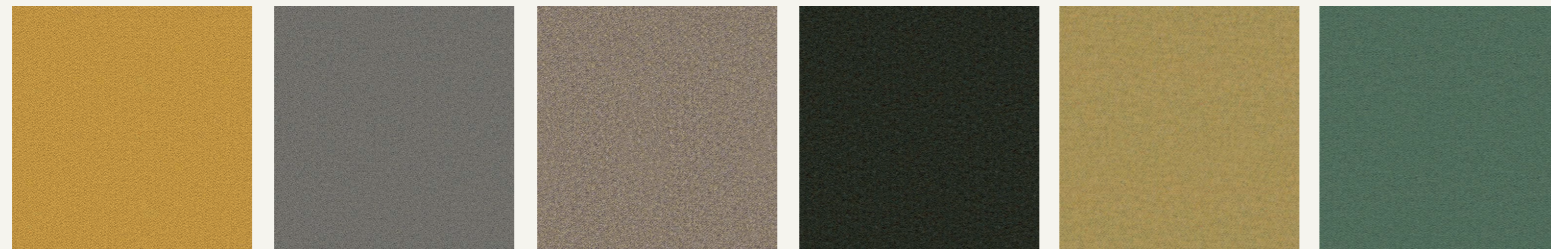

Lateral LDS28
Tylus Synergy

Pair LDS31
Tylus Synergy

Affix LDS32
Tylus Synergy

Couple LDS41
Tylus Synergy

Summon LDS45
Tylus Synergy

Append LDS49
Tylus Synergy

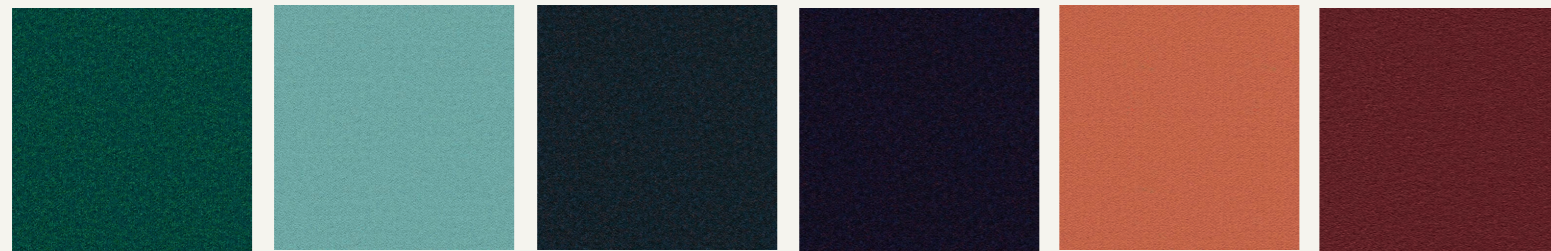

League LDS50
Tylus Synergy

Support LDS55
Tylus Synergy

Accord LDS60
Tylus Synergy

Assemble LDS61
Tylus Synergy

Contribution LDS75
Tylus Synergy

Amiable LDS79
Tylus Synergy

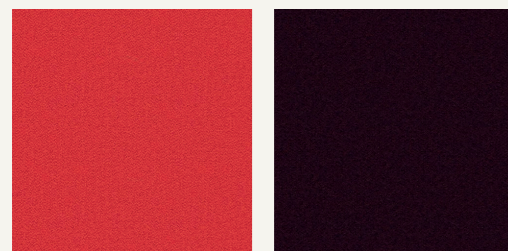

Apt LDS80
Tylus Synergy

Process LDS88
Tylus Synergy

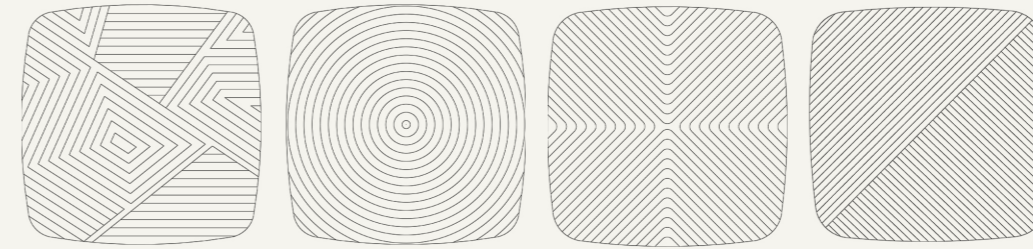

Aztec
Quilting Design

Echo
Quilting Design

Flow
Quilting Design

Lines
Quilting Design

Saddle Leather Handle

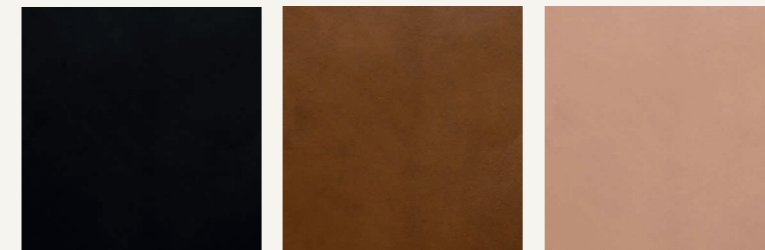

Black
Saddle Leather Handle

Dark Tan
Saddle Leather Handle

Natural
Saddle Leather Handle

Zipper and Tape Finishes

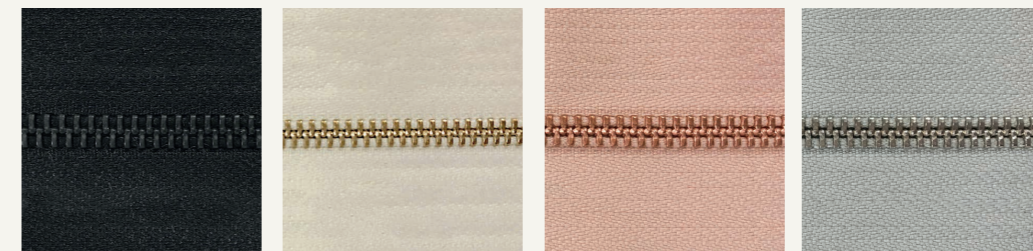

Black Zipper with Black Tape
Zipper and Tape

Gold Zipper with Ivory Tape
Zipper and Tape

Rose Gold Zipper with Peach Tape
Zipper and Tape

Silver Zipper with Gray Tape
Zipper and Tape

a whole world of color

Finish Boxes and Sample Service

Our new Global Colour Palette is now available to order to order your finish and fabric samples, Finish Box and Finish Cards please contact your representative, or email:

finishes@thesenatorgroup.com

Configure your designs

With hundreds of products, fabrics and finish options available Allermuir makes specifying and styling simple. We've even added the option to download custom renders straight to your device. Simply go to every product page at Allermuir.com to configure your product.

Hit 'view in your room' to see every product in the Allermuir range, configured the way you want it, directly in your lounge, office, reception, hotel lobby or cafeteria by the power of VR, all at the touch of a button.

Simply go to any product page on allermuir.com to configure your product.

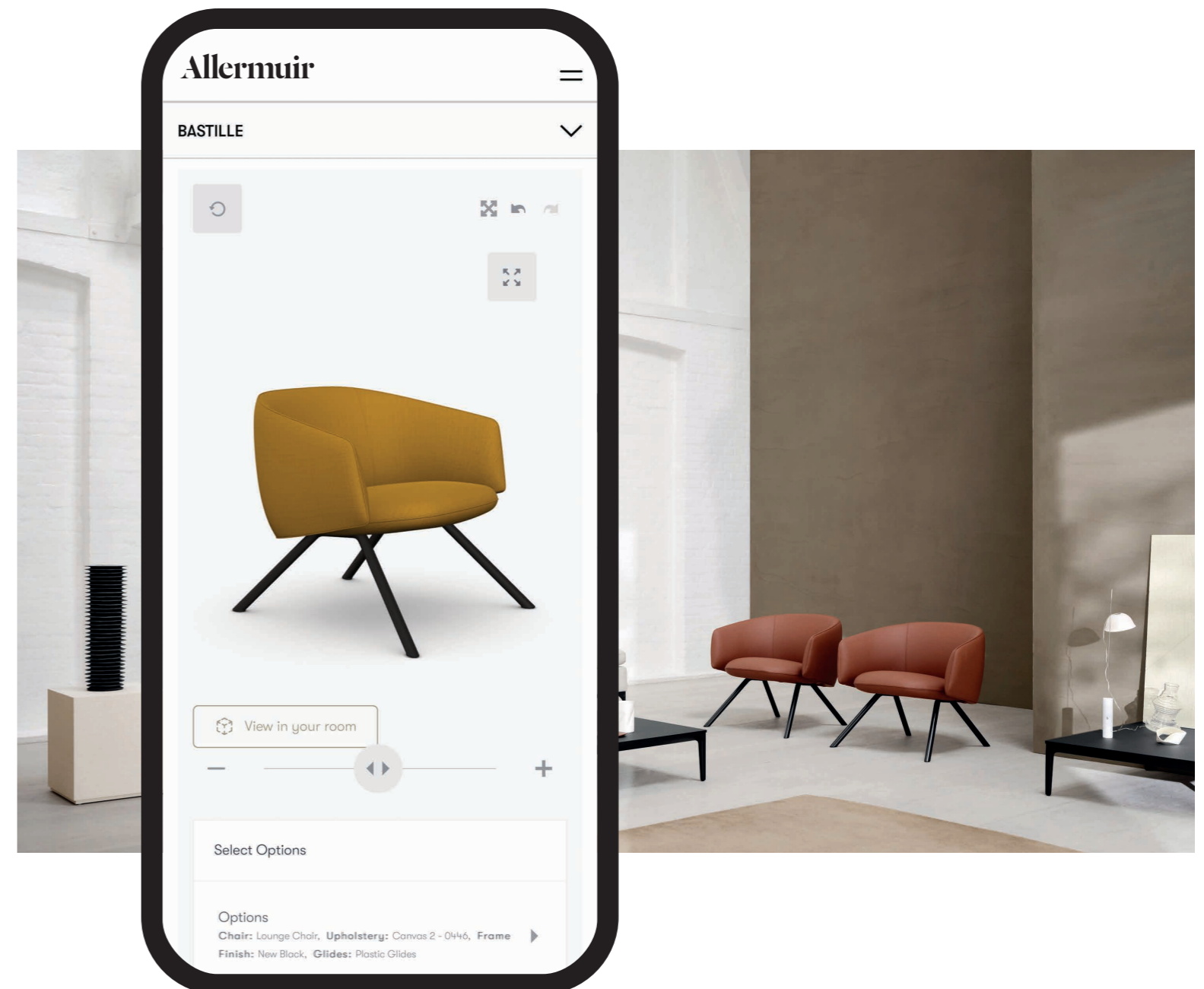

Global Headquarters

Altham Business Park
Accrington, Lancashire
BB5 5YE
United Kingdom

Corporate Headquarters

4111 N. Jerome Road
Maumee, OH
43537
United States

Hong Kong

Suites 2508-2509,
K11 Aterlier,
728 Kings Road,
Quarry Bay
Hong Kong

210

211

London

Back Hill
Farringdon
London EC1R 5EN
United Kingdom

Chicago

222 Merchandise Mart
Floor 11, Suite 1112
Chicago, IL
60654
United States

Bengaluru

No. 295 & 296, 3rd Floor
100 Feet Road
Indiranagar
Bengaluru 560038
India

Birmingham

Sovereign Hall
Frederick Street
Birmingham B1 3HE
United Kingdom

New York

3 East 28th St, 9th Floor
New York, NY
10016
United States

Join the conversation:

@allermuir / allermuir.com

Allermuir *Part of* **The Senator Group**

The Senator Group is the glue that unites all the individual product brands together with exceptional people, service, and unrivalled manufacturing capability.

The Senator Group and its house of brands has grown into one of the largest office furniture manufacturers in the world, remaining an independent, family-owned business meaning attention to detail, integrity, investment in people, and passion for design.

Rather than outsource manufacturing and face the inevitable compromises of oversight and agility that entails, we've continued to invest in highly capable and adaptable production technology. Trusting everything to our own skilled people and keeping our own technology cutting edge is The Senator Group's secret to quality.

www.thesenatorgroup.com

