

Phoulds — PH3

Elegance, poise and comfort were the words that guided the development of Phoulds. Meticulous joining of two pressed plywood shells create the chair's structure which is lined with a distinctive six panel upholstery style. Phoulds offers the diversity of both high and mid back shells and two distinctive support frames. In addition the outer shell has the option of being fully upholstered.



Design by Allermuir

Standard Features

- 6 panel upholstery detail
- Beech shell with a clear finish
- 4 leg tubular steel frame finished in Polished Chrome
- Underseat shroud
- Plastic self leveling glides

Optional Features

- Two tone upholstery
- Beech shell can be stained or color washed
- Walnut veneer shell with a clear finish
- 4 leg tubular steel frame available in a Black powder coat
- Self leveling glides with felt

Performance Standards

ANSI/BIFMA X5.1:2011

Dimensions

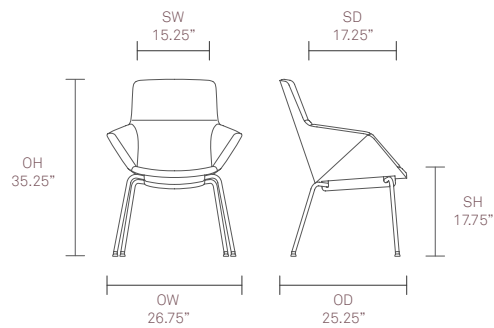

For finish options please refer to website